

PART No. 1487E9P

Data subject to change without notice

Isometric drawing Not to Scale

Gross Automation (877) 268-3700 · www.hammondenclosuresales.com · sales@grossautomation.com

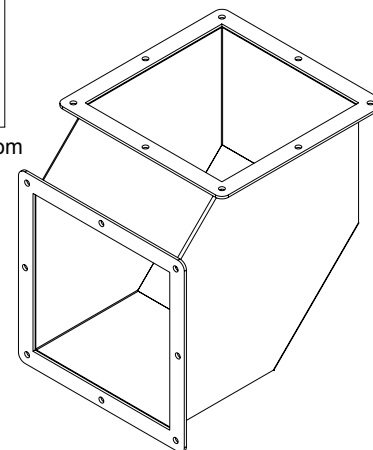

ISOMETRIC VIEW

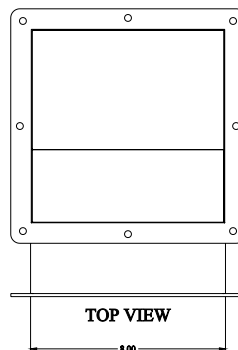

TOP VIEW

8.00

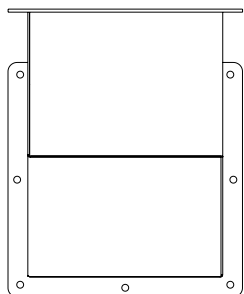

BACK VIEW

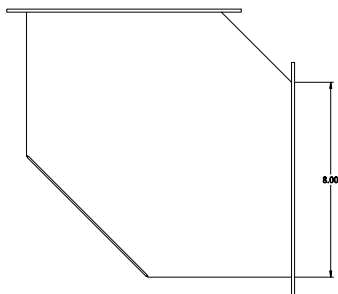

SIDE VIEW

8.00

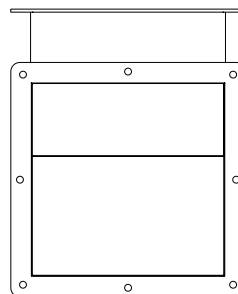

FRONT VIEW

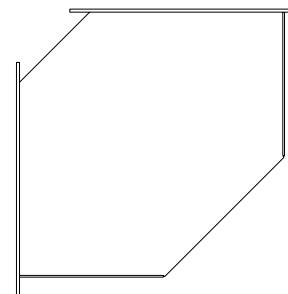

SIDE VIEW

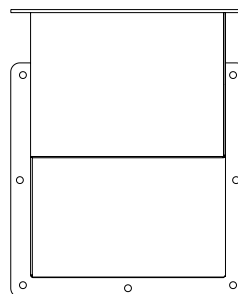

BOTTOM VIEW