

PART No. 1487DX

Data subject to change without notice

Isometric drawing Not to Scale

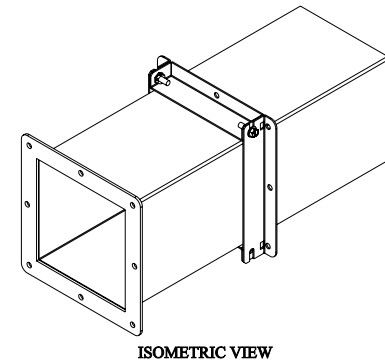
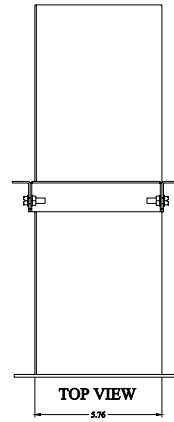

ISOMETRIC VIEW

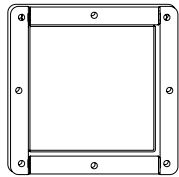

BACK VIEW

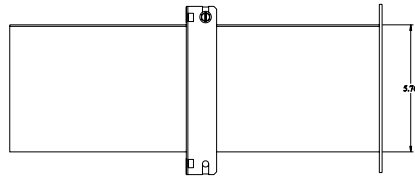

SIDE VIEW

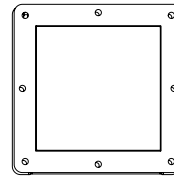

FRONT VIEW

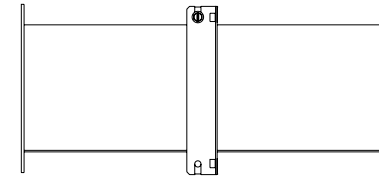

SIDE VIEW

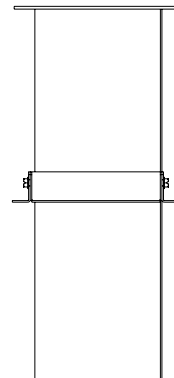

BOTTOM VIEW