

PART No. 1487D36

Data subject to change without notice

Isometric drawing Not to Scale

Gross Automation (877) 268-3700 · www.hammondenclosuresales.com · sales@grossautomation.com

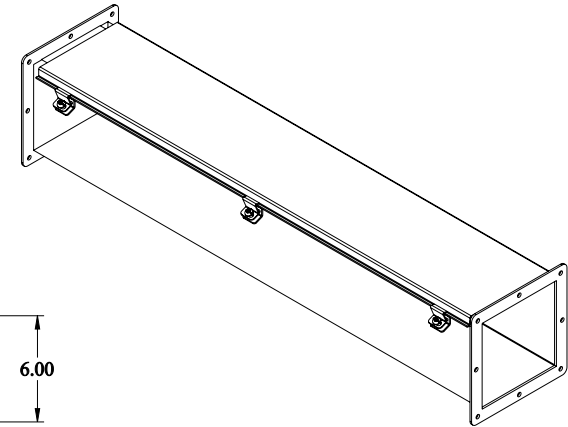

ISOMETRIC VIEW

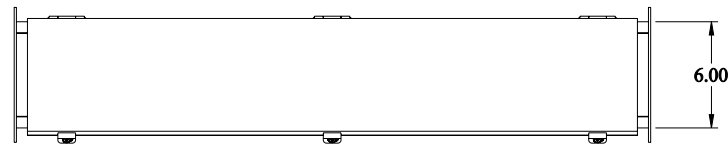

TOP VIEW

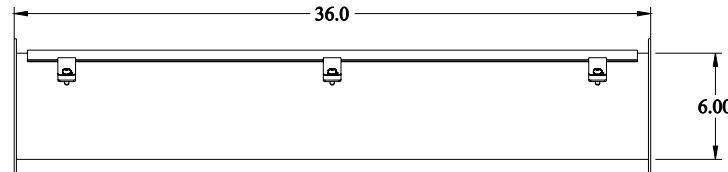

FRONT VIEW

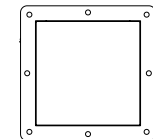

SIDE VIEW

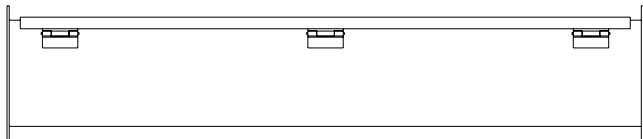

BACK VIEW

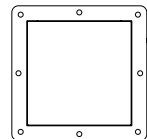

SIDE VIEW

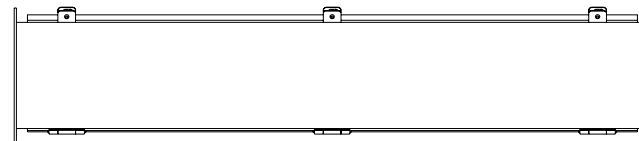

BOTTOM VIEW