

# PART No. 1487CX

Data subject to change without notice

Isometric drawing Not to Scale

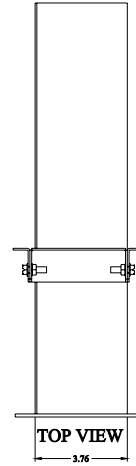

TOP VIEW  
3.76

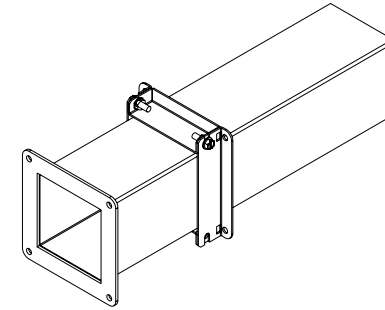

ISOMETRIC VIEW

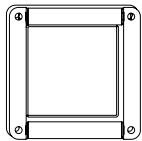

BACK VIEW

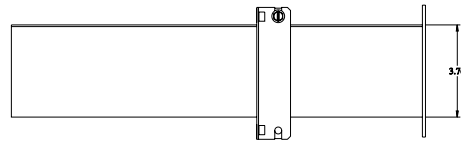

SIDE VIEW  
3.76

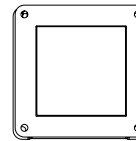

FRONT VIEW

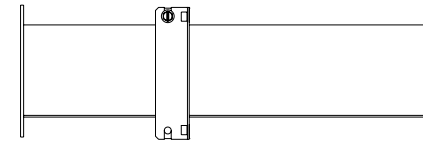

SIDE VIEW

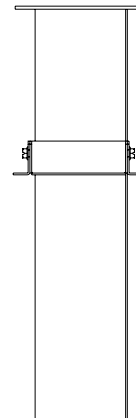

BOTTOM VIEW