

**PART No. 1487CW**

Data subject to change without notice

Isometric drawing Not to Scale

Gross Automation (877) 268-3700 · [www.hammondenclosuresales.com](http://www.hammondenclosuresales.com) · [sales@grossautomation.com](mailto:sales@grossautomation.com)

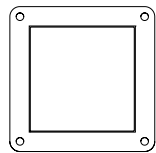

**BACK VIEW**

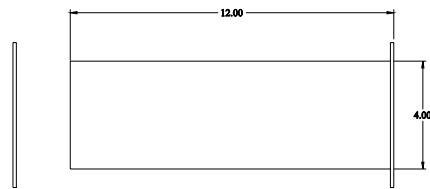

**SIDE VIEW**

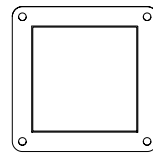

**FRONT VIEW**

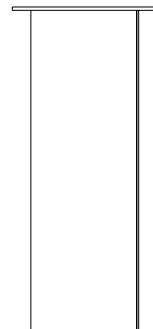

**BOTTOM VIEW**

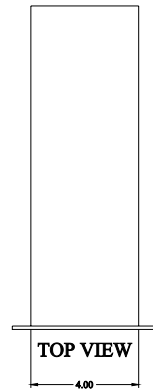

**TOP VIEW**

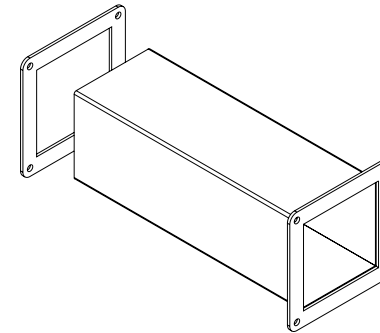

**ISOMETRIC VIEW**

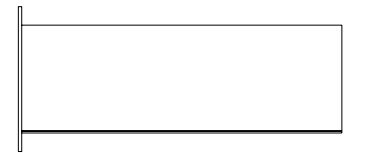

**SIDE VIEW**