

SECTION A-A

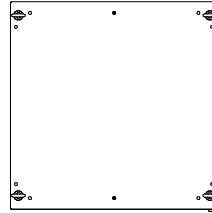

TOP VIEW

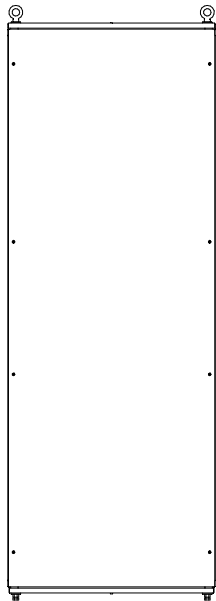
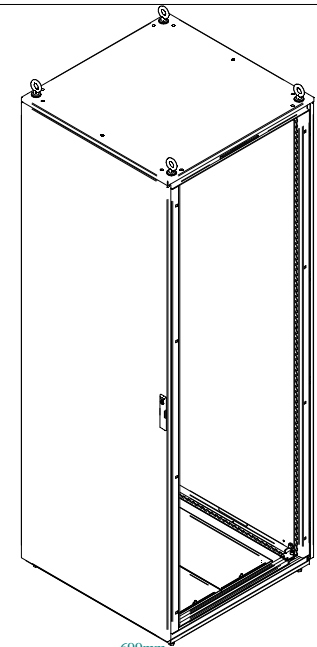

REAR VIEW

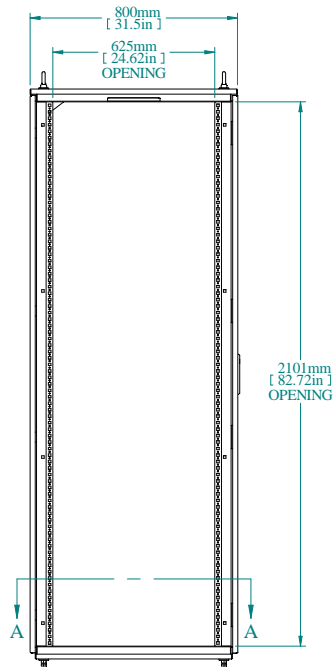

L.S. VIEW

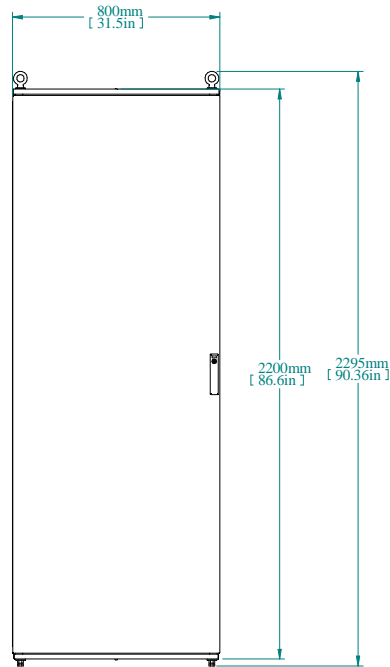

FRONT VIEW

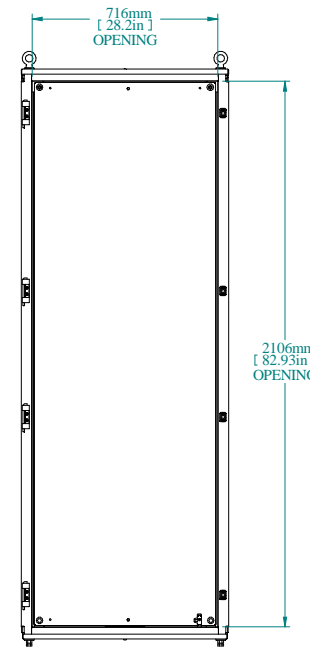

FRONT VIEW DOOR REMOVED

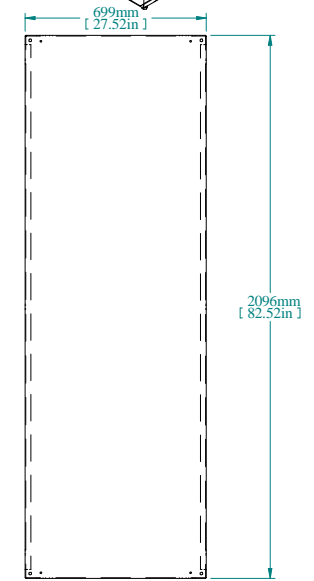

INNER PANEL

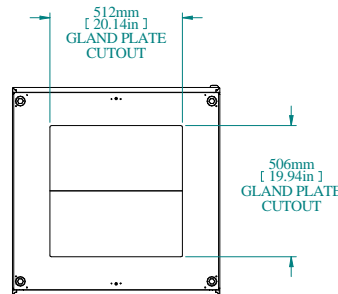

BOTTOM VIEW

| PART NUMBERS | |
|--------------|--------------------------------|
| HME2288 | PAINTED TEXTURED GRAY RAL 7035 |

| NOTES |
|---|
| Welded Assembly See Hammond Website for Additional Accessories |

Data subject to change without notice. Isometric drawing not to scale.



**HAMMOND
MANUFACTURING™**

www.hammondmfg.com

PART NO. HME2288