

SECTION A-A

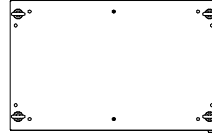

TOP VIEW

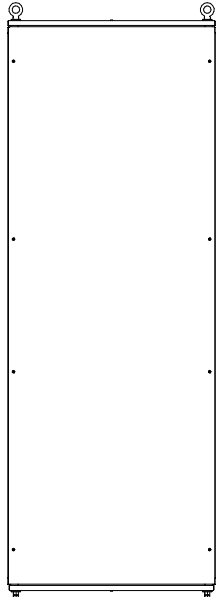
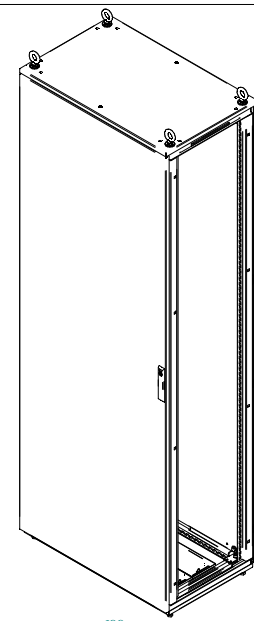

REAR VIEW

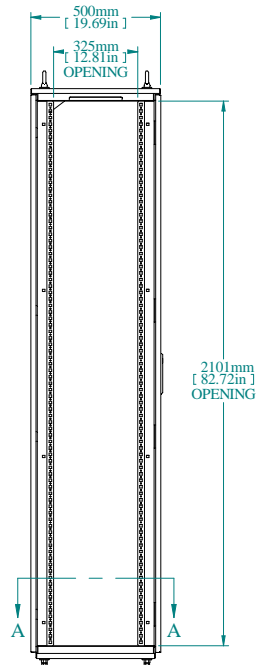

L.S. VIEW

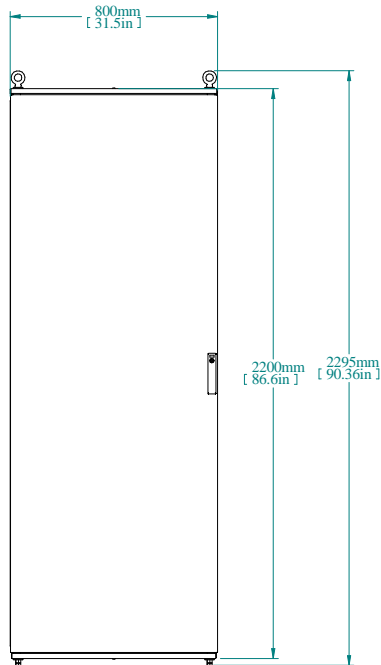

FRONT VIEW

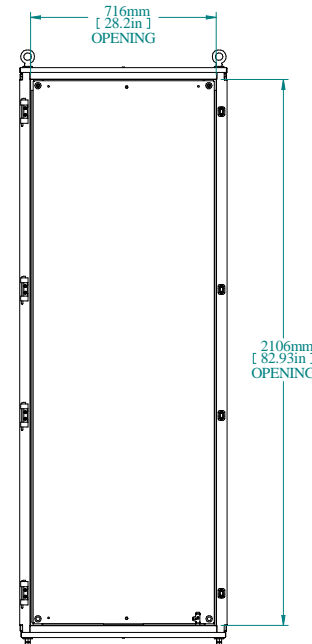

FRONT VIEW DOOR REMOVED

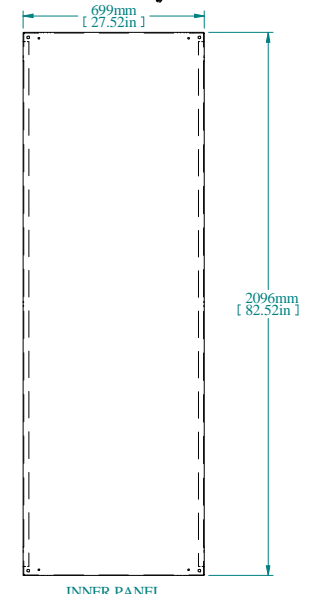

INNER PANEL

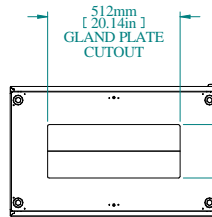

BOTTOM VIEW

206mm
[8.13in]
GLAND PLATE
CUTOUT

PART NUMBERS	
HME2285	PAINTED TEXTURED GRAY RAL 7035

NOTES
Welded Assembly See Hammond Website for Additional Accessories

Data subject to change without notice. Isometric drawing not to scale.

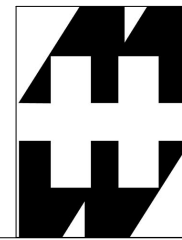

**HAMMOND
MANUFACTURING™**

www.hammondmfg.com

PART NO. HME2285