

REAR VIEW

L.S VIEW

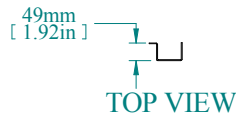

TOP VIEW

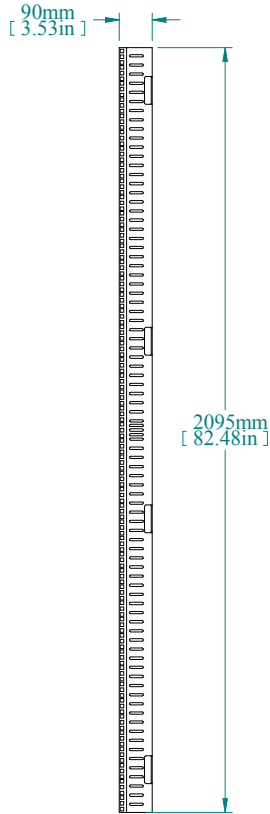

FRONT VIEW



ISOMETRIC VIEW

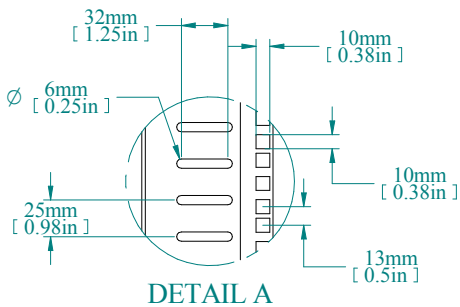

DETAIL A

PART NUMBERS	
HCR22SZPL	12 GAUGE ZINC PLATED (ZPL FINISH)

NOTES
Can mount directly to frame in full front and full back positions or can have full front back depth adjustment when used with depth grid straps.(Sold separately) Provides 19" mounting centers and sold in pairs Hammond Website for Additional Accessories

Data subject to change without notice. Isometric drawing not to scale.

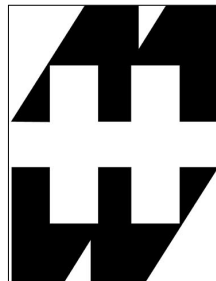

**HAMMOND
MANUFACTURING™**

www.hammondmfg.com

PART NO. HCR22ZPL