

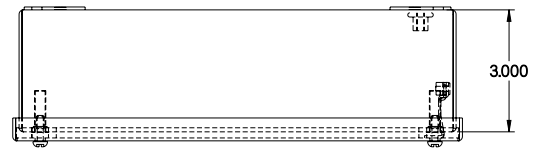

PART No. 1436S

Data subject to change without notice
Isometric drawing Not to Scale



TOP VIEW

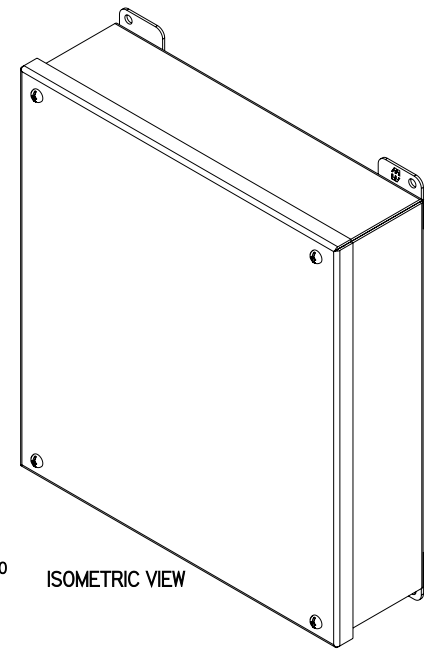

ISOMETRIC VIEW

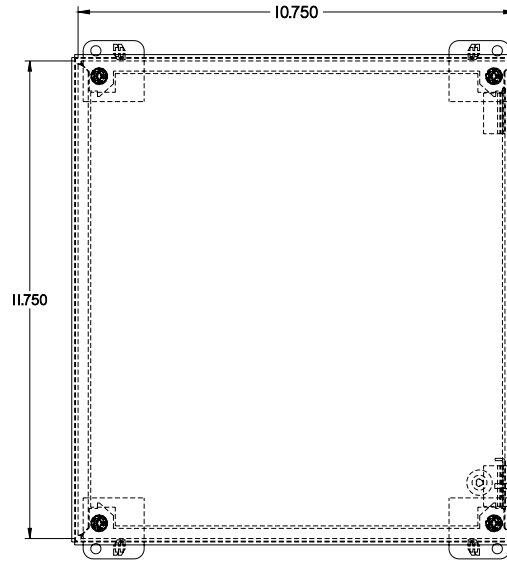

FRONT VIEW

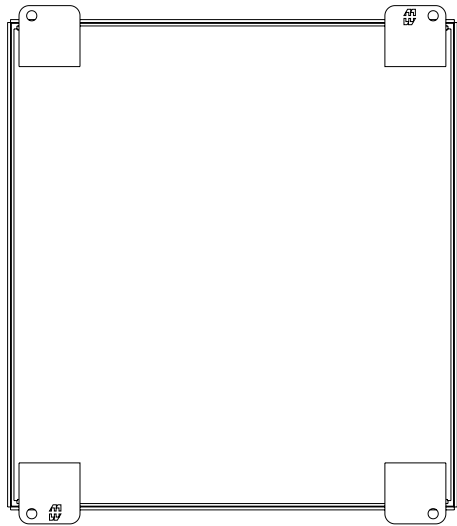

BACK VIEW

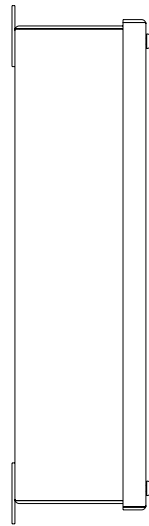

LEFT SIDE VIEW

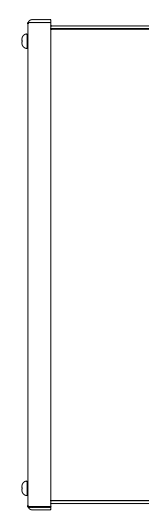

RIGHT SIDE VIEW

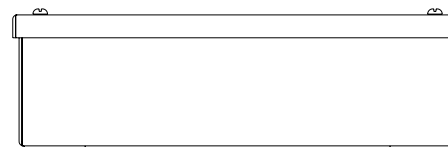

BOTTOM VIEW

Gross Automation (877) 268-3700 · www.hammondenclosuresales.com · sales@grossautomation.com