

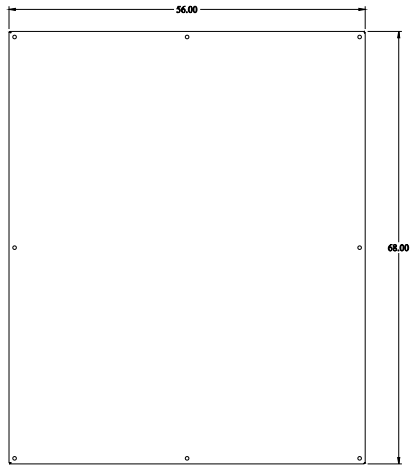

PART No. 1422N4E12F

Data subject to change without notice
Isometric drawing Not to Scale

Gross Automation (877) 268-3700 · www.hammondenclosuresales.com · sales@grossautomation.com



INNER PANEL

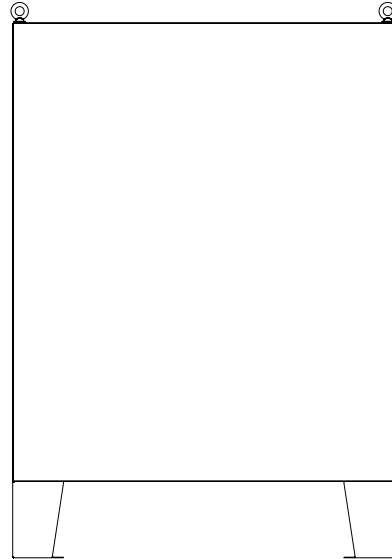

BACK VIEW



SIDE VIEW

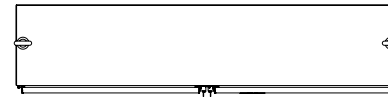

TOP VIEW

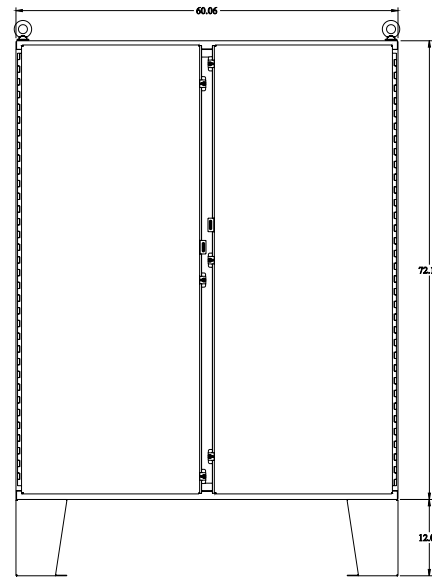

FRONT VIEW

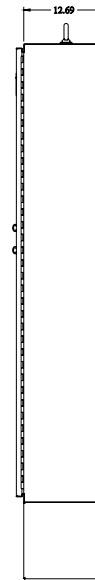

SIDE VIEW

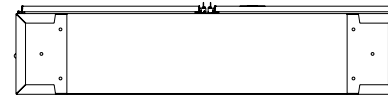

BOTTOM VIEW

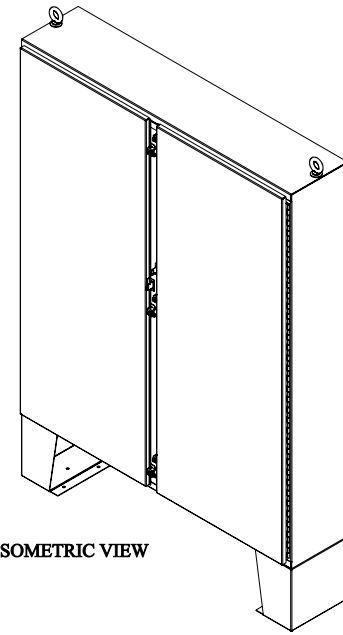

ISOMETRIC VIEW