

**PART No. 1418ZYD24**

Data subject to change without notice  
Isometric drawing Not to Scale

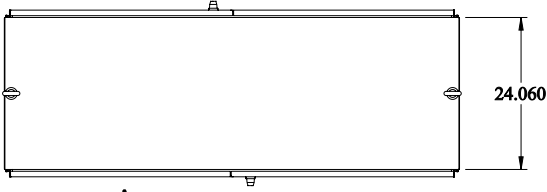

TOP VIEW

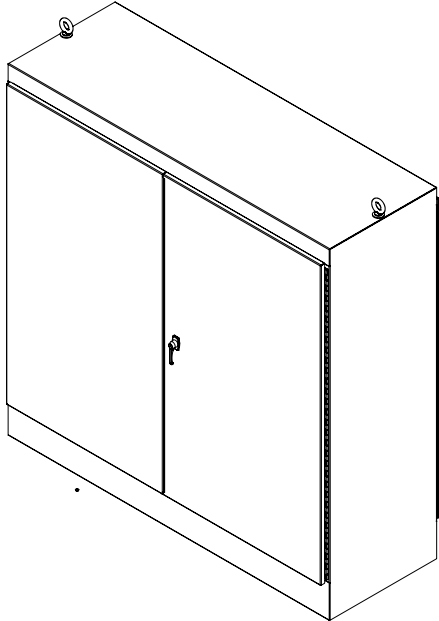

ISOMETRIC VIEW

Gross Automation (877) 268-3700 · [www.hammondenclosuresales.com](http://www.hammondenclosuresales.com) · [sales@grossautomation.com](mailto:sales@grossautomation.com)

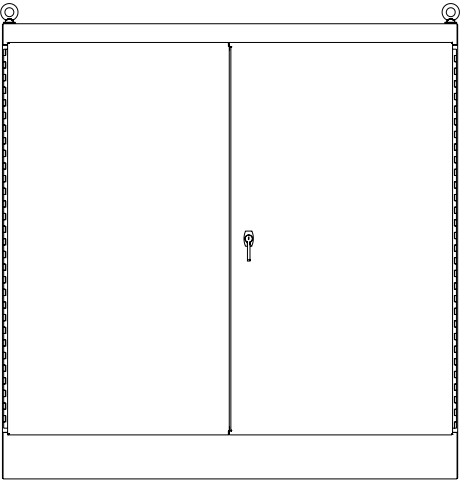

BACK VIEW

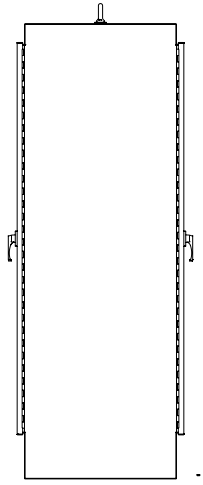

LEFT SIDE VIEW

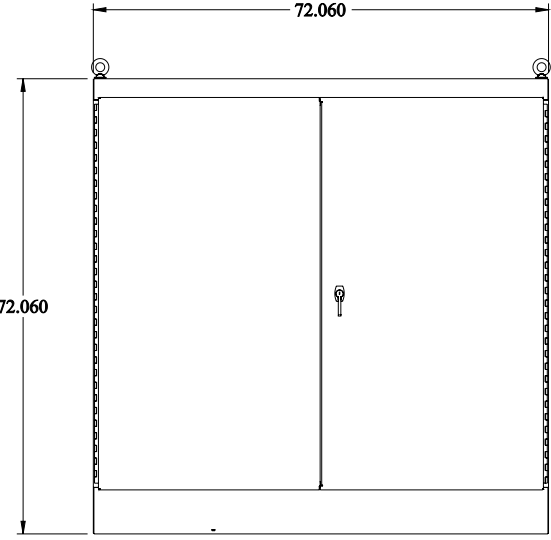

FRONT VIEW

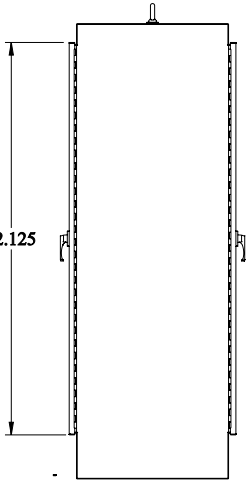

RIGHT SIDE VIEW

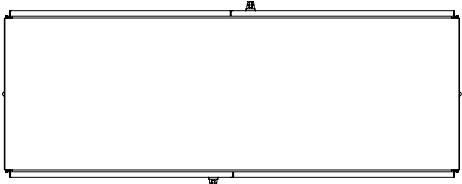

BOTTOM VIEW