



Accessories





Key Features:

- Modern style.
- Rugged endposts made of Polyamid with 30% reinforced glass fiber and molded-in brass inserts.
- Heavy duty extruded anodized aluminum bar handle.
- Sold singly.
- Hardware included
- Three color version available for each size.

Part Number			Units	Dimensions			
Black End Post/Clear Aluminum	Black End Post/Black Aluminum	Grey End Post/Clear Aluminum		Handle Mounting Hole Centers	Height	Screw Thread	Handle Width
1427GBC	1427GBB	1427GGC	inch mm	3.00 76.2	1.64 41.7	M4x10	0.52 13.2
1427NBC	1427NBB	1427NGC	inch mm	3.50 88.9	1.64 41.7	M4x10	0.52 13.2
1427SBC	1427SBB	1427SGC	inch mm	4.00 101.6	1.64 41.7	M4x10	0.52 13.2
1427TBC	1427TBB	1427TGC	inch mm	5.00 127	1.64 41.7	M4x10	0.52 13.2
1427MBC	1427MBB	1427MGC	inch mm	5.30 134.6	1.64 41.7	M4x10	0.52 13.2
1427WBC	1427WBB	1427WGC	inch mm	6.00 152.4	1.64 41.7	M4x10	0.52 13.2
1427LBC	1427LBB	1427LGC	inch mm	7.00 177.8	1.64 41.7	M4x10	0.52 13.2



Key Features:

- Chrome plated round steel
- Sold singly
- Hardware included

Part Number	Units	Dimensions					Designed for Panel Height
		Handle Mounting Hole Centers	Height	Screw Thread	Thread Depth	Handle Diameter	
1427B	inch mm	1.25 31.8	0.625 15.9	4-40	0.156 3.96	0.187 4.75	1.75" (1U)
1427B2	inch mm	1.25 31.8	1.00 25.4	6-32	0.25 6.35	0.187 4.75	1.75" (1U)
1427D	inch mm	1.75 44.5	0.75 19.1	4-40	0.25 6.35	0.187 4.75	5.25" (3U)
1427E	inch mm	2.00 50.8	1.00 25.4	6-32	0.25 6.35	0.187 4.75	5.25" (3U)
1427Q	inch mm	2.30 58.4	0.95 23.8	6-32	0.375 9.53	0.25 6.35	5.25" (3U)
1427P	inch mm	2.8 71.1	0.95 23.8	6-32	0.375 9.53	0.25 6.35	5.25" (3U)
1427G	inch mm	3.00 76.2	1.75 44.5	8-32	0.562 14.27	0.25 6.35	8.75" (5U)
1427N	inch mm	3.50 88.9	1.20 30.5	10-32	0.375 9.53	0.375 9.53	8.75" (5U)
1427N2	inch mm	3.50 88.9	1.50 38.1	8-32	0.562 14.27	0.25 6.35	8.75" (5U)
1427C1	inch mm	4.00 101.6	1.30 33	10-32	0.562 14.27	0.375 9.53	8.75" (5U)
1427S	inch mm	4.00 101.6	1.50 38.1	8-32	0.562 14.27	0.25 6.35	8.75" (5U)
1427S2	inch mm	4.00 101.6	1.75 44.5	8-32	0.562 14.27	0.25 6.35	8.75" (5U)
1427T	inch mm	5.00 127	1.50 38.1	8-32	0.562 14.27	0.25 6.35	12.25" (7U)
1427T2	inch mm	5.00 127	1.75 44.5	8-32	0.562 14.27	0.25 6.35	12.25" (7U)
1427M	inch mm	5.30 134.6	1.20 30.5	10-32	0.375 9.53	0.375 9.53	12.25" (7U)
1427W	inch mm	6.00 152.4	1.50 38.1	8-32	0.562 14.27	0.25 6.35	12.25" (7U)
1427W2	inch mm	6.00 152.4	1.75 44.5	8-32	0.562 14.27	0.25 6.35	12.25" (7U)
1427L	inch mm	7.00 177.8	1.30 33	10-32	0.375 9.53	0.375 9.53	14.00" (8U)



CANADA
Guelph, Ontario (519) 822-2960
St. Laurent, Quebec (514) 343-9010
USA
Cheektowaga, NY (716) 651-0086

www.hammondmfg.com

EUROPE
Basingstoke, UK +44 1256 812812

AUSTRALASIA
Queenstown, SA, Australia +61 8 8240 2244

Handles



1427C2

- 4" (102mm) hole to hole mounting centers
- 4.4" (111mm) length
- 1.3" (33mm) height
- 5/8" x 9/32" (15.9 x 7.14mm) oval, satin nickel finished brass
- 10-32 hardware included
- thread depth is 1/2" (12.7mm)



M268-4

- 7.1" (181mm) hole to hole mounting centers
- 7.6" (194mm) length
- 1.6" (40mm) height
- matte clear anodized aluminum handle
- hardware included
- .48" (12mm) width



1427C5

- 4" (102mm) hole to hole mounting centers
- 4.2" (108mm) length
- 1.3" (34mm) height
- 1/4" x 7/8" (6.35 x 22.2mm) rectangular, clear anodized brushed finish aluminum
- 8-32 hardware included
- thread depth is 7/16" (11.11mm)



M268-5

- 9.3" (237mm) hole to hole mounting centers
- 9.8" (249mm) length
- 1.6" (40mm) height
- matte clear anodized aluminum handle
- hardware included
- .48" (12mm) width



M268-2

- 3.5" (88mm) hole to hole mounting centers
- 4" (102mm) length
- 1.6" (40mm) height
- matte clear anodized aluminum handle
- hardware included
- .48" (12mm) width



1427C6

- 2.7" (70mm) hole to hole mounting centers
- 3.5" (89mm) length
- 1.5" (38mm) height
- clear anodized satin finish aluminum
- 8-32 hardware included
- thread depth is 7/16" (11.11mm)



M268-3

- 4.8" (121mm) hole to hole mounting centers
- 5.3" (134mm) length
- 1.6" (40mm) height
- matte clear anodized aluminum handle
- hardware included
- .48" (12mm) width



M3299-1131

- 1.3" (32mm) hole to hole mounting centers
- 1.7" (42mm) length
- 1.6" (40mm) height
- matte clear anodized aluminum handle
- hardware included
- .30" (8mm) width



M3299-1231

- 3" (75mm) hole to hole mounting centers
- 3.4" (87mm) length
- 1.6" (40mm) height
- matte clear anodized aluminum handle
- hardware included
- .30" (8mm) width



M250-1003

- 4" (102mm) hole to hole mounting centers
- 4.4" (111mm) length
- 1.4" (36mm) height
- black nylon carry handle
- 55 lb. load capacity
- hardware included
- .52" (13mm) width



M3299-1301

- 4.7" (119mm) hole to hole mounting centers
- 5.2" (131mm) length
- 1.6" (40mm) height
- matte clear anodized aluminum handle
- hardware included
- .30" (8mm) width



M250-1393

- 5.6" (141mm) hole to hole mounting centers
- 6.1" (154mm) length
- 1.7" (42mm) height
- black nylon carry handle
- 132 lb. load capacity
- hardware included
- .79" (20mm) width



M286-6

- 3.9" (99mm) hole to hole mounting centers
- 4.6" (118mm) length
- 1.7" (42mm) height
- spring-locked, chrome plated steel folding handle
- carry capacity of 220 lbs. (100kg) per pair
- hardware included
- sold in pairs



1427C4

- 4.4" (111mm) hole to hole mounting centers
- 5" (127mm) length
- 1" (25mm) height
- black anodized satin finish aluminum
- 8-32 hardware included
- thread depth is 3/8" (9.5mm)



M250-663

- 2.7" (67mm) hole to hole mounting centers
- 3" (75mm) length
- 1.3" (32mm) height
- black nylon carry handles
- hardware included



1427F

- 3.7" (94mm) hole to hole mounting centers
- 4.9" (124mm) length
- 2.2" (56mm) height
- black, scratch resistant, light weight polystyrene handle
- 60 lb. load capacity
- nickel plated steel support posts
- hardware included
- .43" (11mm) width



CANADA

Guelph, Ontario (519) 822-2960
St. Laurent, Quebec (514) 343-9010

USA

Cheektowaga, NY (716) 651-0086



EUROPE

Basingstoke, UK +44 1256 812812

AUSTRALASIA

Queenstown, SA, Australia +61 8 8240 2244

Handles & Feet



1427J

- 8.5" (216mm) long
- .77" (20mm) width
- .19" (5mm) height
- 7.25" (184mm) mounting centers
- chrome caps on a fluted soft vinyl strap with a spring steel core
- 50 lb. (23 kg) load capacity
- hardware included



M3255-2001

- 7.6" (194mm) length
- 3" (76mm) height
- .83" (21mm) depth
- silver steel tray
- folding black matte handle
- handle is 6.4" (164mm) wide and 2.3" (59mm) high
- carry capacity of 220 lbs. per pair
- hardware not included
- sold in pairs



1427K

- 5" (128mm) length
- 3.5" (90mm) height
- .68" (17mm) depth
- black plastic tray with grey plastic folding handle
- handle is 4.1" (104mm) wide and 2.5" (63mm) high
- steady load capacity of 75 lbs. per handle
- simple installation: secured by 2 clips (included)



M797-24

- 1.1" (27mm) length
- .64" (16mm) height
- .55" (14mm) depth
- black polyamic fixed rear legs
- hardware included
- sold in pairs



M262-01

- 5.9" (150mm) length
- 4.1" (105mm) height
- .65" (17mm) depth
- galvanized steel, flush mount screw down tray
- polished aluminum handle
- handle is 4.7" (120mm) wide and 3" (77mm) high
- steady load capacity of 330 lbs. per pair
- hardware included
- sold in pairs



M3784-7001

- 2.6" (67mm) length (in closed position)
- 1.8" (46mm) height (in open position)
- black polyamide spring locked folding legs
- hardware included
- sold in pairs



M263-1

- 5.1" (130mm) length
- 3.6" (91mm) height
- .79" (20mm) depth
- black steel tray
- folding, spring loaded polished steel handle
- handle is 4" (102mm) wide and 2.3" (59mm) high
- steady load capacity of 275 lbs. per pair
- hardware not included
- sold in pairs



1427X

- 2.5" (63mm) length (in closed position)
- 1.35" (34mm) height (in open position)
- white ABS plastic folding legs
- sold in pairs

Cable Wraps, Rubber Feet & Bails

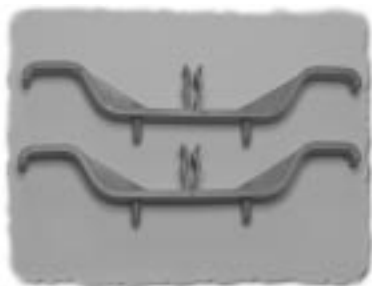

M795

- 4.8" (122mm) overall length
- grey plastic cord wrap
- simple installation: secured by two clips each (included)
- sold in pairs



M795-2

- 5" (126mm) overall length
- zinc plated cord wrap
- mounting hardware not included
- sold in pairs

RUBBER FEET



1421T2



1421T3



1421T4



1421T5CL



1421T6CL



1421T7

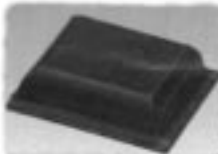

1421T8BK



1421T9BK

Rubber Feet						
Part Number	Description	Color	Dimensions		Style	Pkg. Qty
1421T2	Self-adhesive	Black	.5" x .14"	12.7 x 3.5 mm	Flat Round	24
1421T2CL	Self-adhesive	Clear	.5" x .14"	12.7 x 3.5 mm	Flat Round	24
1421T2GY	Self-adhesive	Grey	.5" x .14"	12.7 x 3.5 mm	Flat Round	24
1421T3	Self-adhesive	Black	.5" x .23"	12.7 x 5.8 mm	Square	24
1421T4	Self-adhesive	Black	.81" x .30"	20.5 x 7.6 mm	Square	24
1421T5BK	Self-adhesive	Black	.44" x .20"	11.1 x 5 mm	Hemisphere	24
1421T5CL	Self-adhesive	Clear	.44" x .20"	11.1 x 5 mm	Hemisphere	24
1421T6CL	Self-adhesive	Clear	.31" x .09"	7.9 x 2.2 mm	Flat Round	24
1421T7	Screw-on	Black	.75" x .5"	19 x 12.7 mm	Round	24
1421T8BK	Self-adhesive	Black	.47" x .12"	12.1 x 3.1 mm	Square	24
1421T9BK	Self-adhesive	Black	.88" x .40"	22.35 x 10.16 mm	Round	24

BAILS

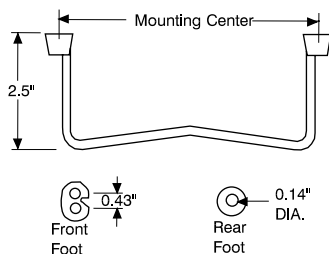

Bails - (Tilt Stand)		
Part Number	Mounting Centers	
	inches	mm
1427D5	5.5	139.7
1427D7	7.0	177.8
1427D10	10.0	254.0



Accessories



CANADA
Guelph, Ontario (519) 822-2960
St. Laurent, Quebec (514) 343-9010
USA
Cheektowaga, NY (716) 651-0086

www.hammondmfg.com

EUROPE
Basingstoke, UK +44 1256 812812

AUSTRALASIA
Queenstown, SA, Australia +61 8 8240 2244

HARDWARE

Part Number	Qty. per pkg.	Hardware Accessories
BH1AAWKIT	1	Battery holder kit for 1 AA cell for 1599 B & E series
BH2AAWKIT	1	Battery holder kit for 2 AA cell for 1599 B & E series
BH1AAAWKIT	1	Battery holder kit for 1 AAA cell for 1599 B & E series
BH2AAAWKIT	1	Battery holder kit for 2 AAA cell for 1599 B & E series
BH3AAAWKIT	1	Battery holder kit for 3 AAA cell for 1599E series
BH4AAAWKIT	1	Battery holder kit for 4 AAA cell for 1599E series
BS61KIT	1	Battery holder kit for 1 - 9V cell for 1599 B & E series
1427KR	1	Key ring kit for 1551 series
1448A20	20	Angles, clips and screws for 1448 rails
1448R6	1	Mounting rails for 1401 & 1458 series (5.6" - 142mm)
1448R8	1	Mounting rails for 1401 & 1458 series (7.6" - 193mm)
1448R10	1	Mounting rails for 1401 & 1458 series (9.6" - 244mm)
1448R12	1	Mounting rails for 1401 & 1458 series (11.6" - 295mm)
1448R14	1	Mounting rails for 1401 & 1458 series 13.6" - 345mm)
1590ORING-100	100	"O" ring for watertight 1590 series
1591AC	1	Clear plastic lid for 1591A series
1591BC	1	Clear plastic lid for 1591B series
1591CC	1	Clear plastic lid for 1591C series
1591DC	1	Clear plastic lid for 1591D series
1591EC	1	Clear plastic lid for 1591E series
1591GC	1	Clear plastic lid for 1591G series
1591HC	1	Clear plastic lid for 1591H series
1591LC	1	Clear plastic lid for 1591L series
1591SC	1	Clear plastic lid for 1591S series
1591TC	1	Clear plastic lid for 1591T series
1591UC	1	Clear plastic lid for 1591U series
1591VC	1	Clear plastic lid for 1591V series
1591Z6	6	P.C. card adaptors for 1590 (L-R) & 1591 series
1591Z50	50	P.C. card adaptors for 1590 (L-R) & 1591 series
1591Z100	100	P.C. card adaptors for 1590 (L-R) & 1591 series
1592ETG	1	Gasket kit for 1592 "T" case
1592ETM	1	Magnetic 3" pad for rear of 1592 "T" case
1592ETRF	6	Rubber feet for 1592 "T" case
1592ETV	1	Velcro mounting pad for 1592 "T" case
1593DIR10	10	Infrared panels for 1593D
1593NIR10	10	Infrared panels for 1593N
1593PIR10	10	Infrared panels for 1593K,L, P, Q, Y & X
1593SIR10	10	Infrared panels for 1593S & T
1594AZ25	25 sets	P.C. card guides for 1594A series
1594AD5	5 sets	P.C. card guides for 1594A series
1594BZ25	25 sets	P.C. card guides for 1594B series
1594BD5	5 sets	P.C. card guides for 1594B series
1594CZ25	25 sets	P.C. card guides for 1594C series
1594CD5	5 sets	P.C. card guides for 1594C series
1594DZ25	25 sets	P.C. card guides for 1594D series
1594DD5	5 sets	P.C. card guides for 1594D series
1594EZ25	25 sets	P.C. card guides for 1594E series
1594ED5	5 sets	P.C. card guides for 1594E series
1598PLABK	2	Black plastic end panels for 1598A series
1598PLBBK	2	Black plastic end panels for 1598B series
1598PLBBBK	2	Black plastic end panels for 1598BB series
1598PLCBK	2	Black plastic end panels for 1598C series
1598PLDBK	2	Black plastic end panels for 1598D series
1598PLEBK	2	Black plastic end panels for 1598E series
1598PLFBK	2	Black plastic end panels for 1598F serie
1598PLGBK	2	Black plastic end panels for 1598G serie
1598PLHBK	2	Black plastic end panels for 1598H series
1598PLJBK	2	Black plastic end panels for 1598J series

HARDWARE con't.

Part Number	Qty. per pkg.	Hardware Accessories
1598TH1	1	Tilt handle for 1598C,E,F & G
1598TH2	1	Tilt handle for 1598H & J
1598ZPC25	25	Circuit board clips for 1598 series
1598ZPC100	100	Circuit board clips for 1598 series
1599BD5	5	Plastic battery dividers for 1599B series
1599BD100	100	Plastic battery dividers for 1599B series
1599CLIP	1	Black nylon belt or pocket clip with hardware
1599CLIPGY	1	Grey nylon belt or pocket clip with hardware
1599ED5	5	Plastic battery dividers for 1599E series
1599ED100	100	Plastic battery dividers for 1599E series
1599HD5	5	Plastic battery dividers for 1599H series
1599HD100	100	Plastic battery dividers for 1599H series

SCREWS

Part Number	Qty per pkg.	Replacement & Accessory Screws	Screw Size
1421J6	6	Self tapping for most metal case series	6-32 philips, nickel plated
1455MS100	100	Machine screws for clear anodized 1455 series	-
1455MS100BK	100	Machine screws for black anodized 1455 series	-
1551ATS100	100	Self tapping type for 1551 series	#2 x 3/16" nickel plated
1590MS100	100	Machine type for 1590 (except L, M & R) series	6-32 x 1/2" nickel plated
1590MS50BK	50	Black machine type for 1590 series	6-32 x 1/2"
1590MS50BU	50	Blue machine type for 1590 series	6-32 x 1/2"
1590MS50GY	50	Grey machine type for 1590 series	6-32 x 1/2"
1590WMS100	100	Stainless steel machine screw for 1590 watertight series	6-32 x 1/2"
1590WMS100BK	100	Black stainless steel machine screw for 1590 watertight series	6-32 x 1/2"
1591MS100	100	Machine type for 1591 & 1598 series	M3 - 0.5 x 10mm
1591MS100BK	100	Black machine type for 1591 & 1598 series	M3 - 0.5 x 10mm
1591TS100	100	Self tapping type for 1591 styrene and 1551 series	#4 x 0.5" nickel plated
1591TS100BK	100	Black self tapping type for 1591 styrene and 1551 series	#4 x 0.5"
1593ATS50	50	Self tapping pan head for 1593, 1591 flange lid & 1599 series	#4 x 1/4" (6.4mm)
1593ATS100	100	Self tapping pan head for 1593, 1591 flange lid & 1599 series	#4 x 1/4" (6.4mm)
1593KS100	100	Self tapping, oval head for 1593K,L & X series	#4 x 0.875" (22.2mm)
1593MS100	100	Self tapping, oval head for 1593S & T series	#4 x 0.625" (15.9mm)
1594MS100	100	Machine type for 1594, 1599B, and 1592 series	M3 - 0.5 x 18mm
1594QS100	100	Self tapping, oval head for 1593J,N,P,Q,D & Y series	#4 x 0.75" (19.1mm)
1594TS100	100	Self tapping for 1594 & 1599ES styrene series	#4 x 25.4mm (1")
1594WMS100	100	Machine type for 1594 watertight series & 1599E	M3 - 0.5 x 25mm
1595MS100	100	Machine type for 1595 series	M3 - 0.5 x 8mm
1598ATS100	100	Screws for stand-off bosses in 1595 & 1598	#6 x 1/4" (6.4mm)
1598TS100	100	Self tapping for 1598 styrene series	#4 x 5/8"
1599BTS100	100	Self tapping for 1599BS styrene series	#4 x 3/4"

DIN CLIPS

1427DINCLIP

- Designed for mounting enclosures to DIN rails
- Includes hardware (Qty. 4 of a #5 self tapping screw) & drilling template
- Center to center hole spacing is 1.18" (30mm)
- Material is a rugged glass filled, black nylon (UL94-VO flammability rating)
- Units are 1.8" (45.7mm) long, 0.4" (10.0mm) wide - overall
- Sold in packages of 2



Flange Kits & P.C. Board Adaptors

PLASTIC FLANGE KITS

Flange kits mount to the rear of our 1591 series (using glue)...

Three sizes cover our entire 1591 series...

Flange kits can be screwed to the lid of our 1591 series...

Flange slots allow for easy cable tie hanging...

Box Mount

Used with Enclosure	Box mounted flange Part Number
1591L	1591F1BK-10
1591A	1591F1BK-10
1591B	1591F1BK-10
1591C	1591F1BK-10
1591D	1591F2BK-10
1591E	1591F3BK-10
1591G	1591F2BK-10
1591H	1591F1BK-10
1591M	1591F1BK-10
1591S	1591F2BK-10
1591T	1591F2BK-10
1591U	1591F3BK-10
1591V	1591F3BK-10

SOLD IN PACKS OF 10

Molded in the same high quality, high strength, fire retardant ABS plastic (black only) as our 1591 series.

NOTE: When gluing flanges to ABS plastic boxes we recommend standard ABS cement. To glue flanges to our styrene enclosures we recommend a faster setting glue like Loctite's "Quick Tite"

Lid Mount

Used with Enclosure	Lid mounted flange Part Number
1591L	1591F1BK-10
1591A	1591F1BK-10
1591B	1591F1BK-10
1591C	1591F2BK-10
1591D	1591F2BK-10
1591E	1591F3BK-10
1591G	1591F3BK-10
1591H	1591F2BK-10
1591M	1591F1BK-10
1591S	1591F3BK-10
1591T	1591F2BK-10
1591U	1591F3BK-10
1591V	1591F3BK-10

SOLD IN PACKS OF 10

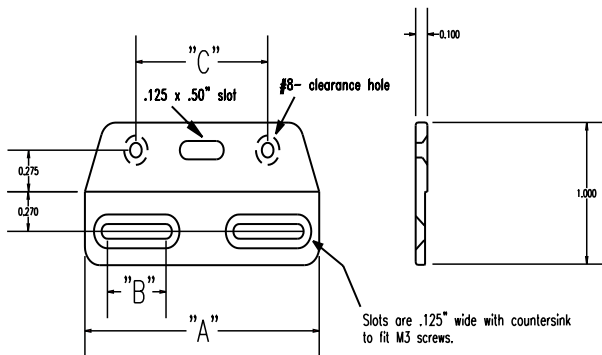

Part Number	Units	Dimensions		
		A	B	C
1591F1BK-10	inch mm	2.2 56	.25 6.4	1.5 38
1591F2BK-10	inch mm	3.0 76	.26 6.6	2.0 51
1591F3BK-10	inch mm	4.5 114	.60 15	3.25 83

P. C. CARD ADAPTORS

P.C. Board Card Adaptors

Allows horizontal mounting of P.C. board(s). **For the 1591 and ribbed 1590 series only.**

- 1591Z6 - Package of 6
- 1591Z50 - Package of 50
- 1591Z100 - Package of 100

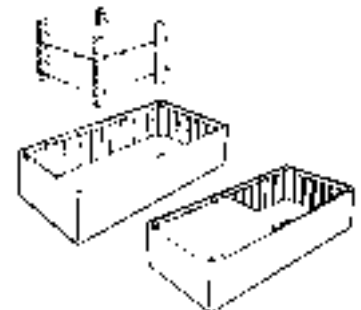

www.hammondmfg.com



We have attempted to make this one of the easiest catalogs in the industry to use! By doing so, we decided not to print all - part by part “detail” dimensions of each model. We are focusing on our website as **THE** central location for this type of information. Our goal, is that it will become one of your favorite tools when choosing enclosures, transformers & outlet strips! A summary of what is available on our site:

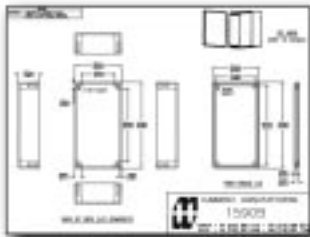

Individual part number dimension drawings in color, downloadable in Adobe Reader PDF format . Readable and printable in high resolution!

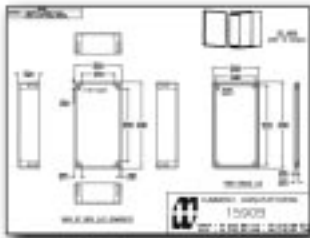

Individual part number dimension drawings in AutoCAD formats...

AND

- Color photo tables with thumbnail previews for each part number...
- Distributor locations and links - we have teamed up with the best in the industry to bring you our products **fast**. Many complete with “on-line” order entry...
- NEW products, technical data, engineering bulletins, etc. for fast downloading...
- FAST e-mail links to our marketing department to order our other product catalogs...
- Links to other Hammond Manufacturing divisions...
- and much, much more....even a link to the fascinating Hammond “Museum of Radio”



CANADA
Guelph, Ontario (519) 822-2960
St. Laurent, Quebec (514) 343-9010
USA
Cheektowaga, NY (716) 651-0086



EUROPE
Basingstoke, UK +44 1256 812812

AUSTRALASIA
Queenstown, SA, Australia +61 8 8240 2244

Technical Information

Properties of Plastic Materials							
Property	Units	Test Method	ABS	ABS Flame Retardant	Polystyrene	Poly-carbonate	Fiber Reinforced Polyester
Mechanical Properties							
Tensile strength @ yield	PSI	ASTMD638	5890	5250	3200	10000	6000
Tensile elongation @ break	%	ASTMD638	22	15	50	100	0.5
Tensile modulus	PSI	ASTMD638	290,000	260,000	285,000	810,000	1,600,000
Flexural modulus	PSI	ASTMD790	290,000	260,000	285,000	810,000	1,600,000
Flexural Strength	PSI	ASTMD790	8200	6800	18100	17000	15000
Izon impact (1/8") - notched	FT LB/IN	ASTMD256	4.5	3.9	2.1	16	4.5
Specific gravity - solid	-	ASTMD792	1.04	1.22	1.17	1.2	1.95
Hardness, Rockwell R	R	ASTMD785	100	100	40	118	40
(Bercol Scale)							
Thermal Properties							
Melt index	GM/10-MIN	ASTMD1288	3	4	3	7	-
Heat Deflection Temp @455 KPA	°F(C)	ASTMD648	205(96)	185(85)	188(87)	284(140)	392(200)
Heat Deflection Temp @1820 KPA	°F(C)	ASTMD648	181(83)	165(74)	-	268(131)	-
Vican softening temperature	°F(C)	ASTMD1525	217(103)	190(88)	203(95)	310(154)	-
Flame characteristics	-	UL94	HB	VO	HB	HB	VO
Thermal conductivity	W/M.C	ASTMC177	0.19	-	0.16	0.19	0.001
Electrical Properties							
Specific volume resistance	Ohm/cm	ASTMD257	10 E15	10 E13	10 E16	10 E16	10 E15
Dielectric strength	V/MIL	ASTMD149	140	400	215	160	400
Other Properties							
Water absorbtion	%	ASTMD570	0.3	-	0.1	0.15	0.16
* Material classified 94HB is combustible!							
Values noted above are typical values for reference only. These values may vary between material manufacturers and within normal manufacturing tolerances.							

Resistance of material to different media				
Material	Polystyrene	ABS	Flame Retard.ABS	Poly-carbonate
Gasoline	-	0	0	-
Diesel Oil	-	+	+	0
Sea Water	+	+	+	-
Hydrochloric Acid, 10%	+	+	0	+
Weak Alkaline	+	+	+	-
Strong Alkaline Solution	+	+	+	-
Atmospheric Influences	0	0	0	+
Lactic Acid	+	+	+	+
Acetone	-	-	-	-
Value at room temperature: + = stable, 0 = relatively stable, - = unstable				
Simultaneous exposure to different media may alter the resistive properties of a material! To be safe, it is advisable to test the cases for sufficient resistance to the material under the condition of the specific application.				

Flammability Rating

94 V-0

Test samples are extinguished within 5 seconds average time. None of the test samples burn longer than 10 seconds. No test samples emit burning particles.

94 V-1

Test samples are extinguished within 25 seconds average time. None of the test samples burn longer than 60 seconds. No test samples emit burning particles.

94 V-2

Similar to 94 V-1, except test samples emit burning particles during the test. The test sample is extinguished in all cases mentioned above. If the sample continues to burn after 25 seconds a horizontal test can be performed to meet classification.

Degree of protection - "IP" Codes Information

Example:

IP 55

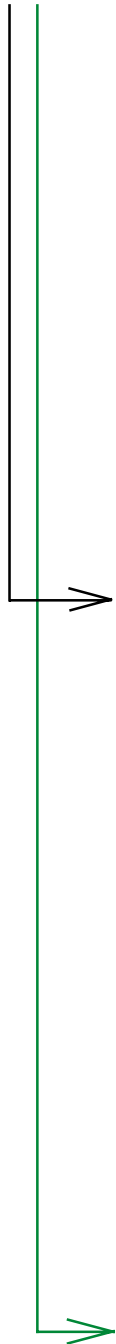

I.P. Protection Classification		
Degrees of contact prevention and guarding against foreign objects		
1st I.P. Digit	Designation	Explanation
0	No protection	No protection of personnel from direct contact with active or moving parts. No protection from access of solid foreign object.
1	Protection against large foreign bodies	Protection of personnel from accidental large area direct contact with active or internal moving parts (hand contact etc.) but no guard against intentional access to such parts. Protection from access of solid foreign object larger than 12 mm in diameter.
2	Protection against medium foreign bodies	Protection of personnel from finger contact with active or internal moving parts. Protection from access of solid foreign object larger than 12 mm in diameter.
3	Protection against small foreign bodies	Protection of personnel from touching active or internal moving parts with tools, wires or similar foreign objects thicker than 2.5 mm. Protection from access of solid foreign matter larger than 2.5 mm in diameter.
4	Protection against granular foreign bodies	Protection of personnel from touching active or internal moving parts with tools, wires or similar foreign objects thicker than 1 mm.
5	Protection from deposit of dust	Total protection of personnel from touching voltage carrying or internal moving parts. Protection from harmful deposit of dust. Access of dust is not completely prevented.
6	Protection from access of dust	Total protection of personnel from touching voltage carrying or internal moving parts. Protection from access of dust.

I.P. Protection Classification		
Degrees of water protection		
2nd I.P. Digit	Designation	Explanation
0	No protection	No special protection
1	Protection against water dripping vertically	Water drops falling vertically must not have any harmful effect.
2	Protection against water dripping off vertically	Water drops falling at any angle up to 15° from the vertical must not have any harmful effect.
3	Protection against spray water	Water drops falling at any angle up to 15° from the vertical must not have any harmful effect.
4	Protection against splash water	Water splashing against the object from all directions must not have any harmful effect.
5	Protection against jet water	A jet of water nozzled from all directions must not have any harmful effect.
6	Protection against flooding	Water from temporary flooding, such as heavy seas, must not enter in any harmful quantity.
7	Protection in dipped state	If the object is dipped into water under the defined conditions of pressure and time, water must not enter it in any harmful quantity.
8	Protection in submerged state	If the object is submerged in water, water must not enter in any harmful quantity.



Series Index

Description	Page	Description	Page	Description	Page
1401.....	78	1555.....	8,9	1596.....	47
1402.....	76,77	1590.....	50,51	1597.....	35
1411.....	95	1590 bottom flange.....	54,55	1598 ABS.....	42,43
1412.....	95	1590 flanged lid.....	52,53	1598 polystyrene.....	44,45
1415.....	96	1590 PC card guides.....	56,57,58	1599.....	36,37,38,39
1421T.....	105	1590 watertight.....	62,63	500-519.....	92,93
1426.....	79	1590 watertight with bottom flange.....	66,67	BH.....	36,40
1427.....	101,102,103,104,105,107	1590 watertight with flanged lid.....	64,65	BS.....	36,40
1431.....	97	1590Z.....	68,69,70,71	DIN Clips.....	107
1434.....	98	1590ZGRP.....	34	Flange Kits.....	108
1441.....	97	1591 ABS.....	14,15	Handles.....	101,102,103,104
1444.....	98	1591 bottom flange.....	22,23	Hardware.....	106,107
1451.....	99	1591 clear lid.....	14,16,22	M.....	102,103,104,105
1452.....	80	1591 flanged lid.....	18,19,20,21	Modifieds.....	CVR3
1453.....	87	1591 polystyrene.....	16,17	RMCP.....	75
1454.....	81	1591 translucent.....	12,13	RMCS.....	74,75
1455.....	82,83,84,85,88	1592.....	24,25	RMCV.....	74,75
1456.....	88,89,90,91	1593.....	26,27,28,29	RMP.....	75
1458.....	86	1594 ABS.....	30,31	SCEM.....	94
1551.....	10,11	1594 polystyrene.....	32,33	Screws.....	107
1554.....	4,5,6,7	1595.....	41	Technical Information.....	110,111

NEED MORE INFORMATION?

For detailed drawings, CAD files and color photos visit our website at:
www.hammondmg.com

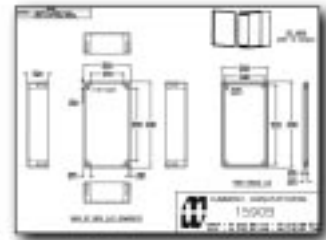
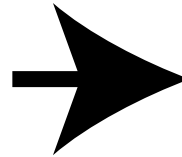

K99

RCS



CANADA

Guelph, Ontario (519) 822-2960
 St. Laurent, Quebec (514) 343-9010

USA

Cheektowaga, NY (716) 651-0086



EUROPE

Basingstoke, UK +44 1256 812812

AUSTRALASIA

Queenstown, SA, Australia +61 8 8240 2244

a factory modified Hammond enclosure!

- Fast turnaround on prototypes...
- Start-up quantities through full "production" runs...

Machining

Silk Screening

Hot Stamping

Special Colors

Custom Materials



Easy to quote and order!

- Mark up the drawings in this catalog & fax or mail, or...
- Mark up our PDF drawings downloadable from our website, or...
- Modify our AutoCAD files downloadable from our website...
- and e-mail us at: modifieds@hammondmfg.com



HAMMOND MANUFACTURING™



CANADA

Hammond Mfg. Co. Ltd.
394 Edinburgh Rd., North
Guelph, Ontario N1H 1E5
Tel: (519) 822-2960
Fax: (519) 822-0715

EUROPE

Hammond Electronics Limited
1 Onslow Close
Kingsland Business Park
Basingstoke
RG24 8QL
United Kingdom
Tel: +44 1256 812812
Fax: +44 1256 332249

AUSTRALASIA

Hammond Electronics Pty. Ltd.
11 - 13 Port Road
Queenstown, SA 5014
Australia
Tel: +61 8 8240 2244
Fax: +61 8 8240 2255

USA

Hammond Mfg. Co. Inc.
256 Sonwil Dr.
Cheektowaga, NY 14225
Tel: (716) 651-0086
Fax: (716) 651-0726

Les Fabrications Hammond
(Quebec) Inc.
4240 Seré Street
St. Laurent, Quebec H4T 1A6
Tel: (514) 343-9010
Fax: (514) 343-9941

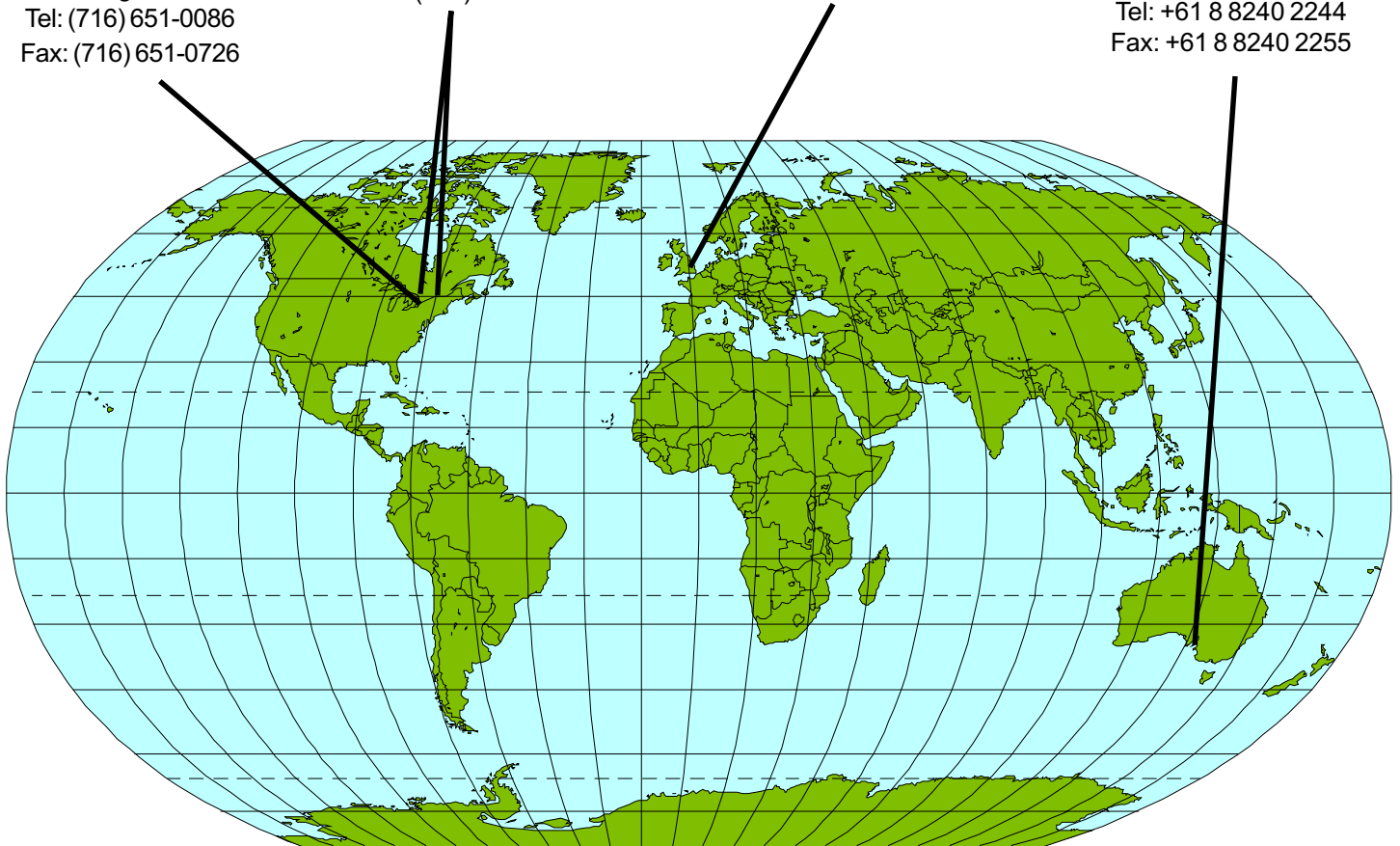

www.hammondmfg.com