

DATE	SYM.	DESCRIPTION	DR	CK	REL

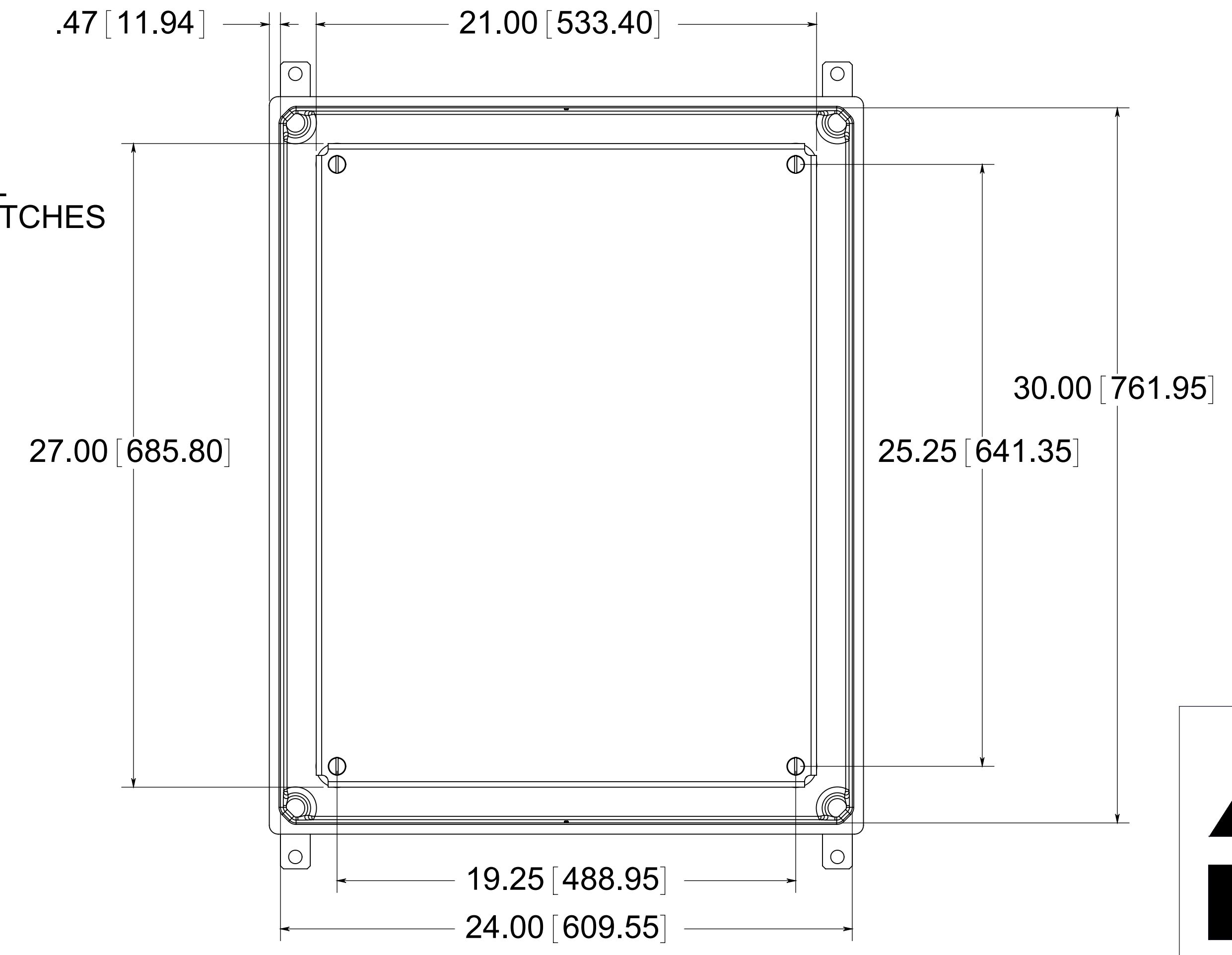
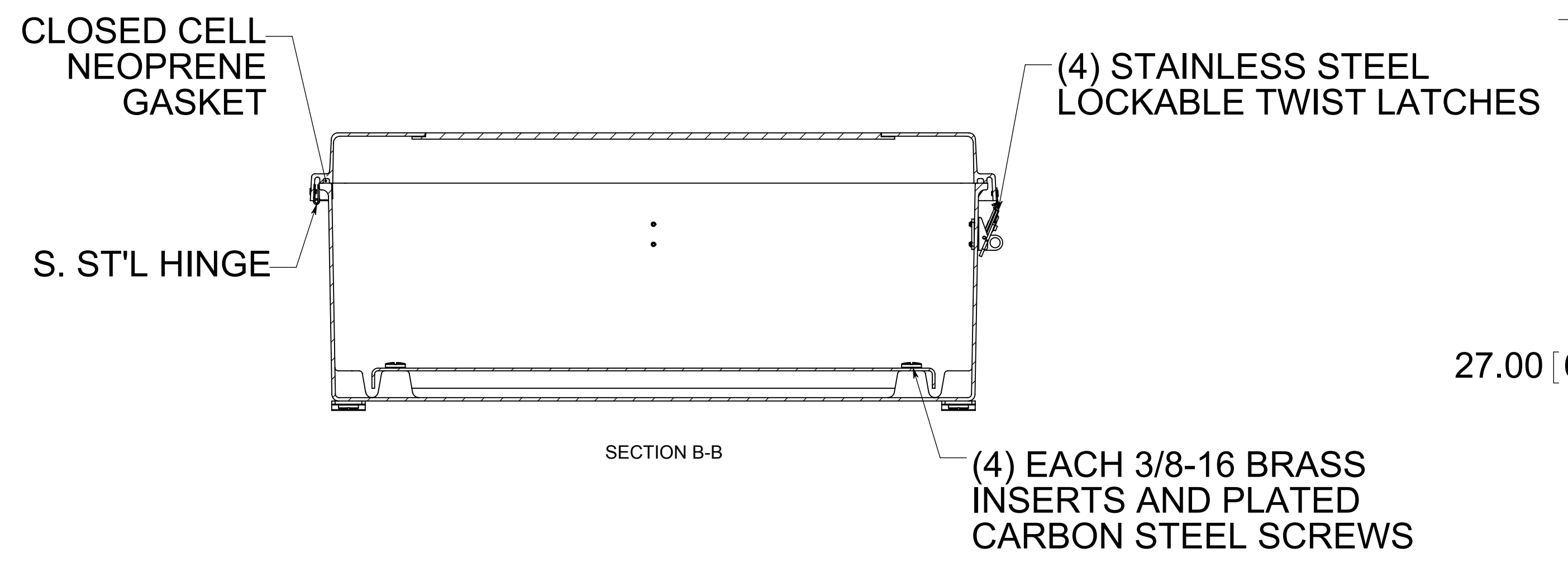
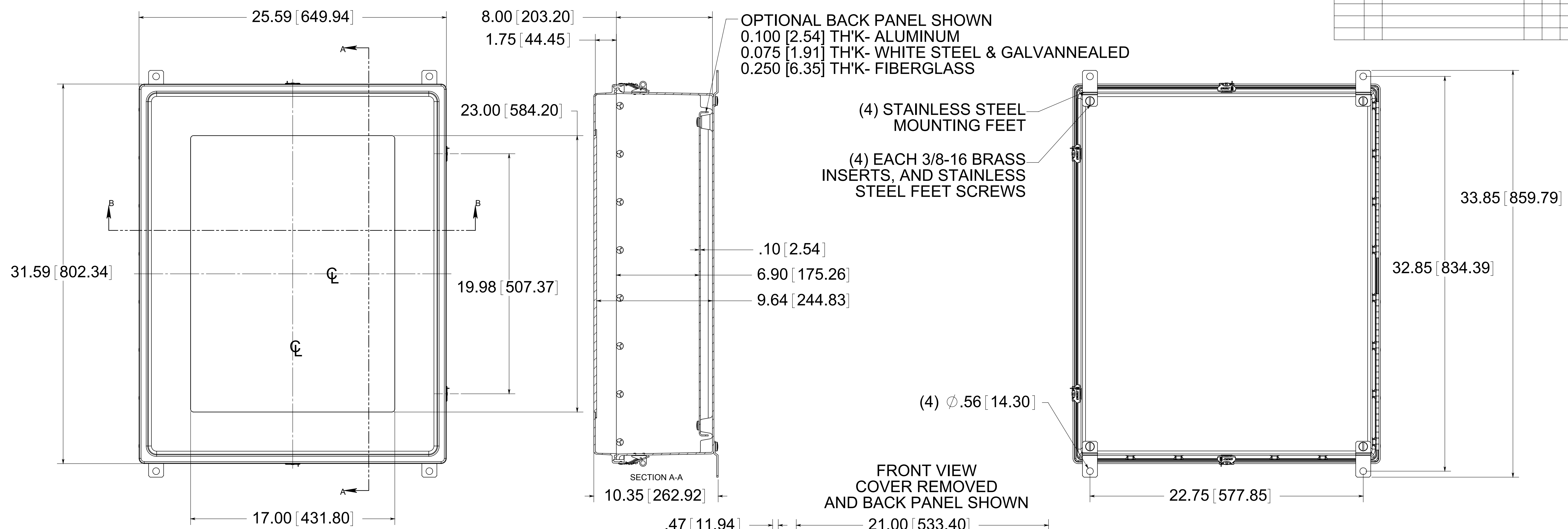

**MATERIAL:**  
BOX- COMPRESSION MOLDED FIBERGLASS REINFORCED POLYESTER  
COVER- COMPRESSION MOLDED FIBERGLASS REINFORCED POLYESTER  
WINDOW- POLYCARBONATE

**PART No. PJ30248RTW**  
for more information visit  
[www.hammfg.com](http://www.hammfg.com)  
Data subject to change without notice  
Drawing Not to Scale