

PART No. 1418N4SSS8
Data subject to change without notice
Isometric drawing Not to Scale

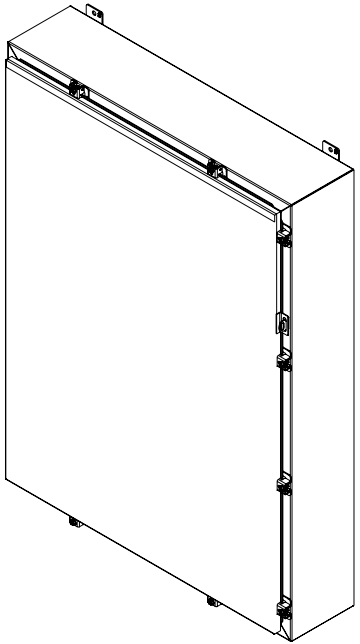

ISOMETRIC VIEW

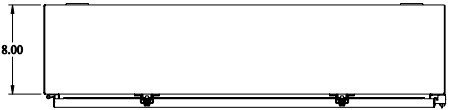

TOP VIEW

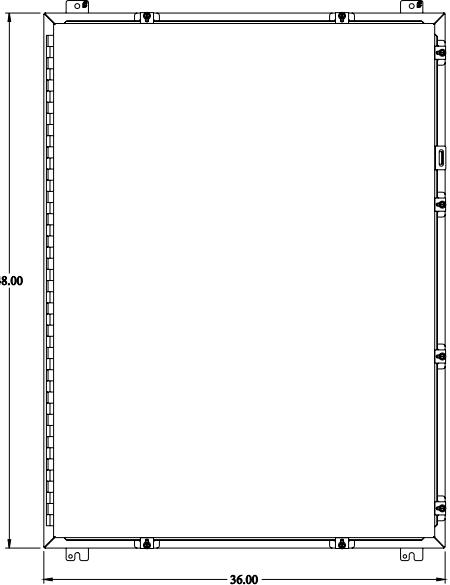

FRONT VIEW

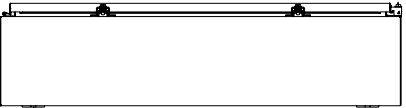

BOTTOM VIEW

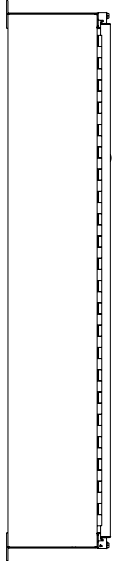

SIDE VIEW

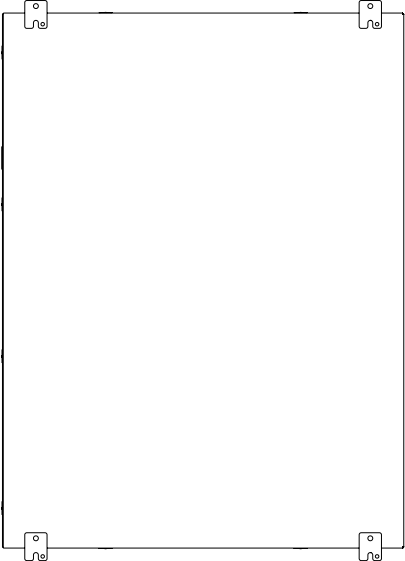

BACK VIEW

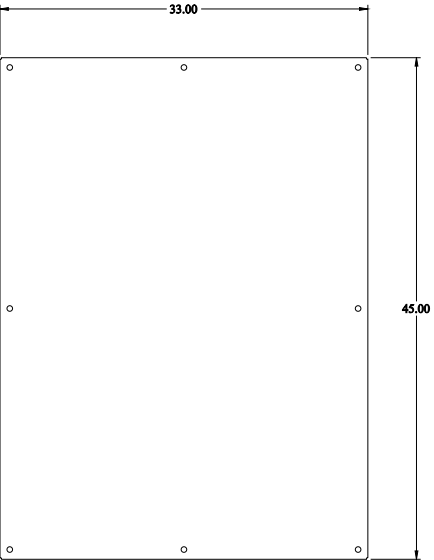

INNER PANEL