

PART No. 1418N4SSO10

Data subject to change without notice
Isometric drawing Not to Scale

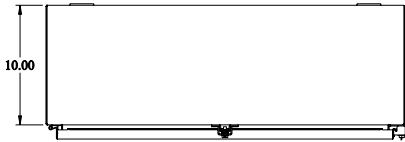

TOP VIEW

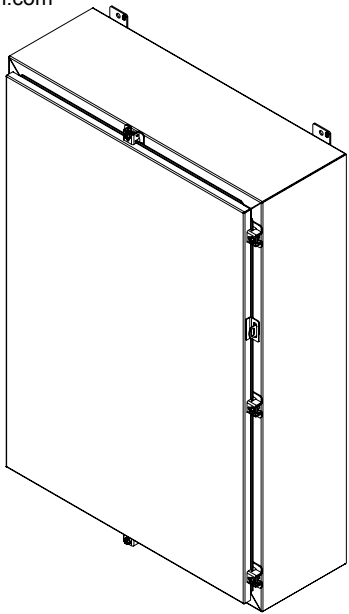
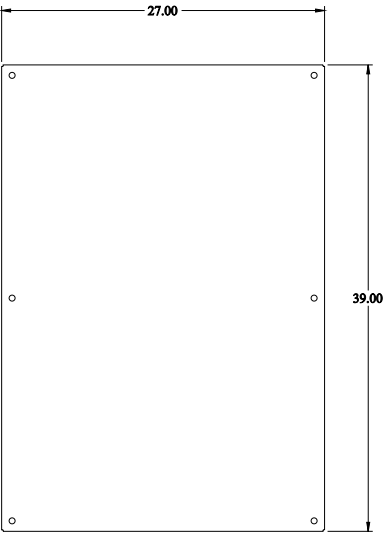

INNER PANEL

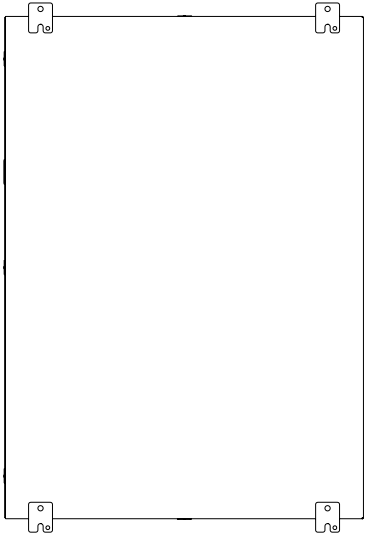

BACK VIEW

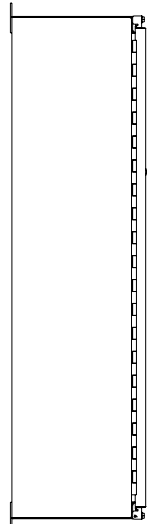

SIDE VIEW

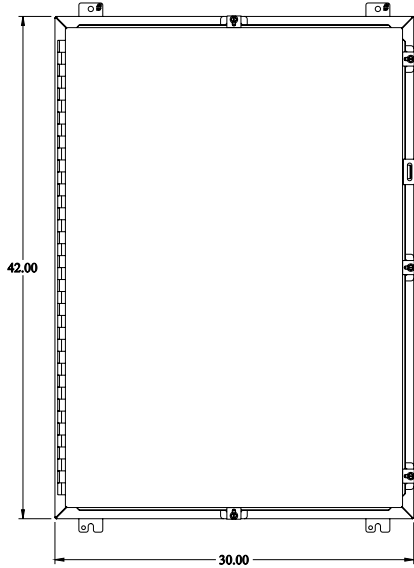

FRONT VIEW

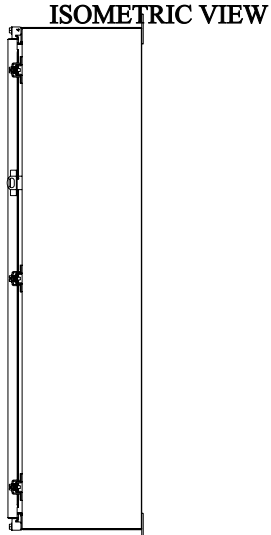

ISOMETRIC VIEW

SIDE VIEW

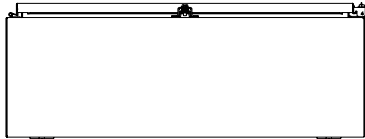

BOTTOM VIEW