

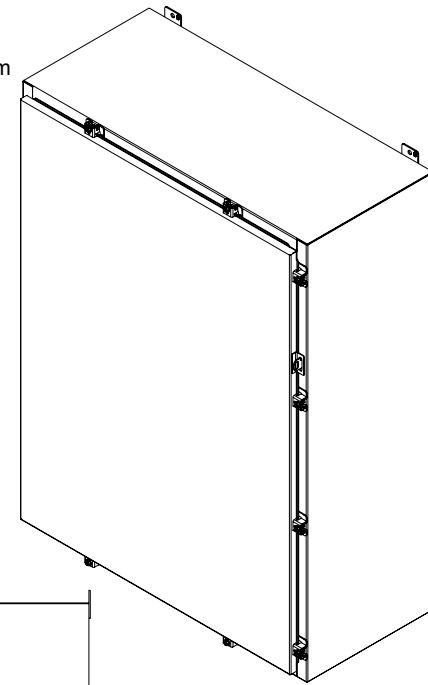

PART No. 1418N4S16S16

Data subject to change without notice

Isometric drawing Not to Scale



ISOMETRIC VIEW

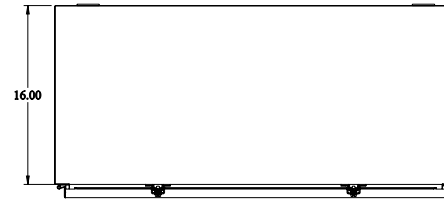

TOP VIEW

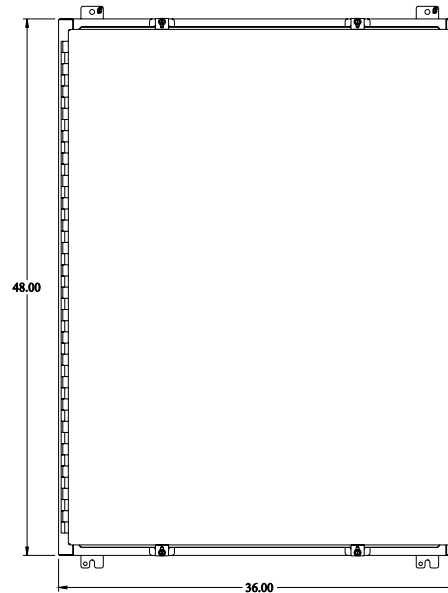

FRONT VIEW

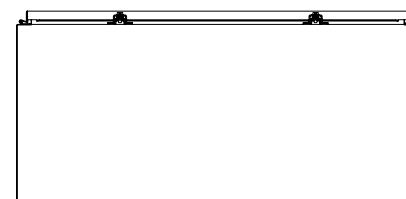

BOTTOM VIEW

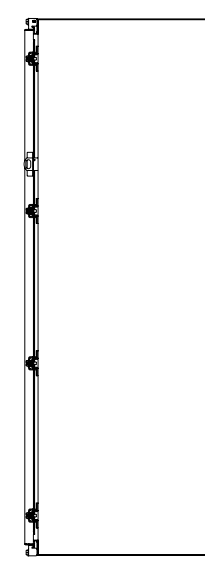

SIDE VIEW

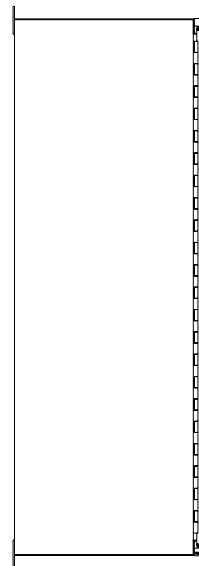

SIDE VIEW

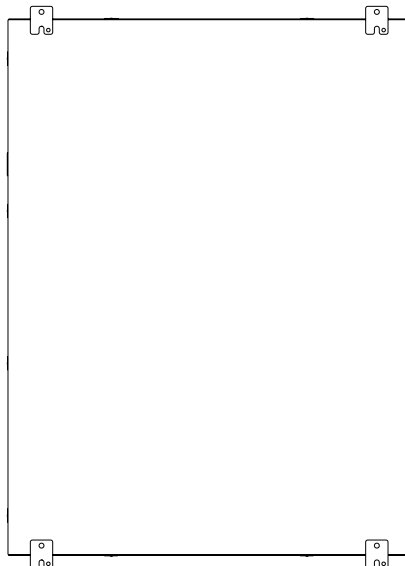

BACK VIEW

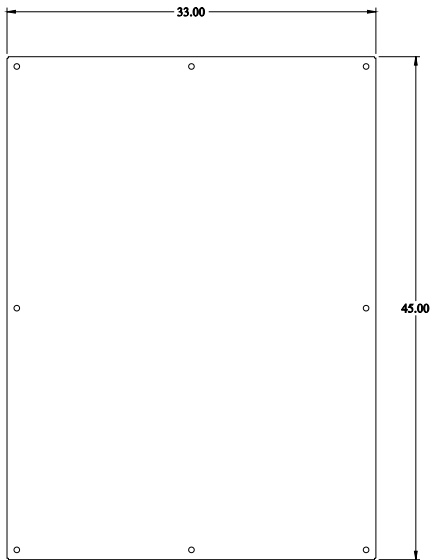

INNER PANEL