

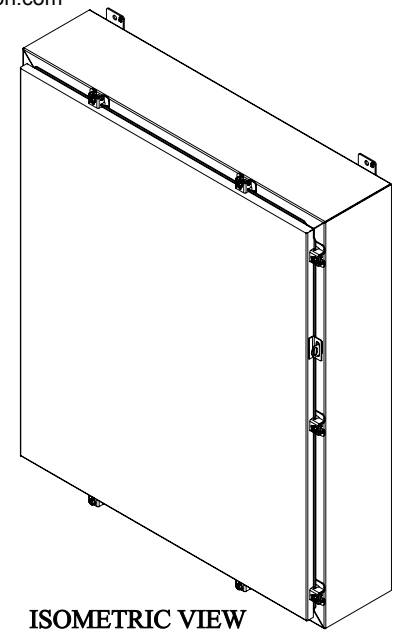

PART No. 1418N4S16P8

Data subject to change without notice

Isometric drawing Not to Scale



ISOMETRIC VIEW

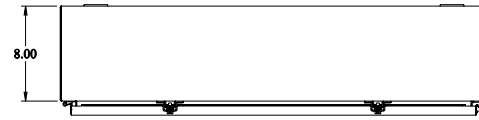

TOP VIEW

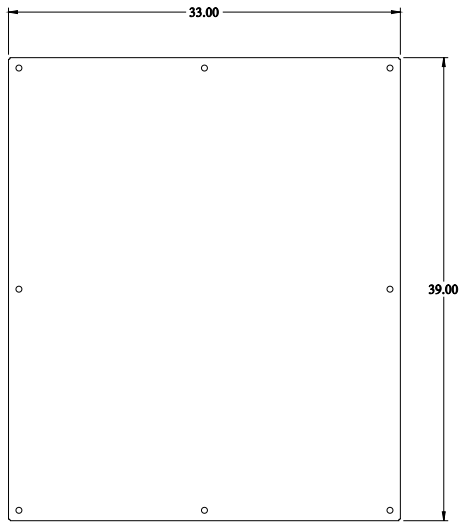

INNER PANEL

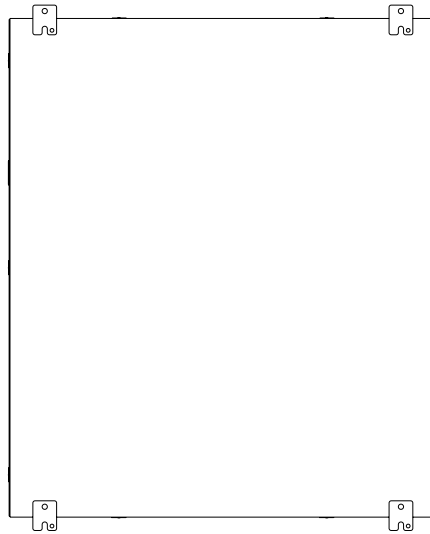

BACK VIEW

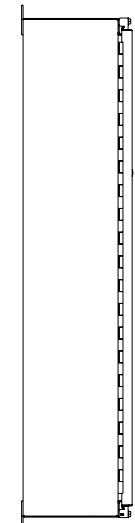

SIDE VIEW

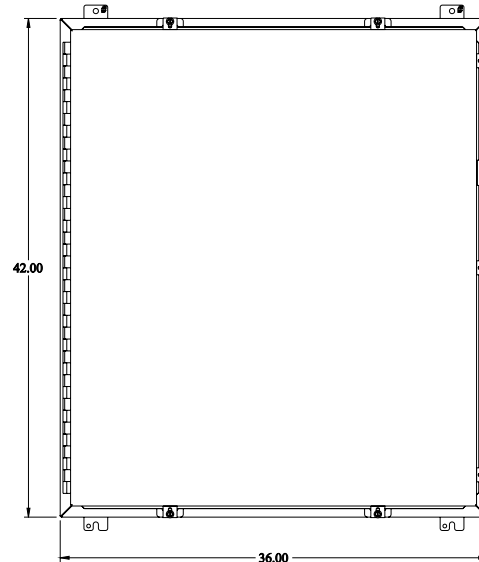

FRONT VIEW

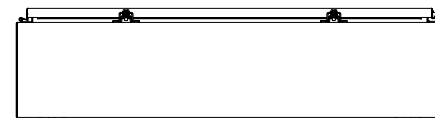

BOTTOM VIEW

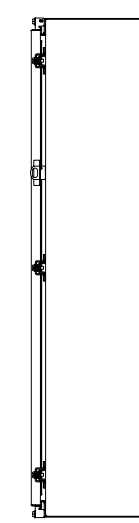

SIDE VIEW