

**PART No. 1418N4S16O10**  
Data subject to change without notice  
Isometric drawing Not to Scale

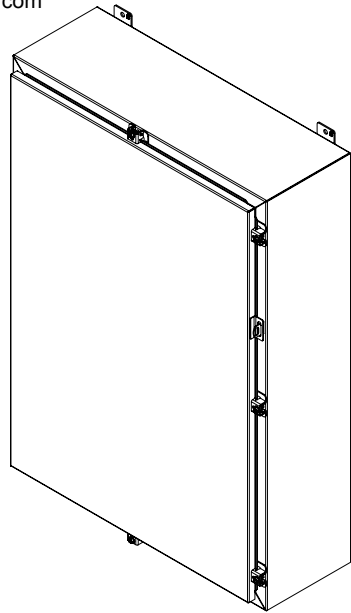

**ISOMETRIC VIEW**

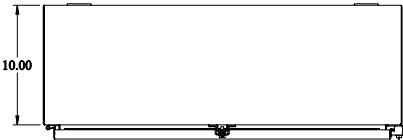

**TOP VIEW**

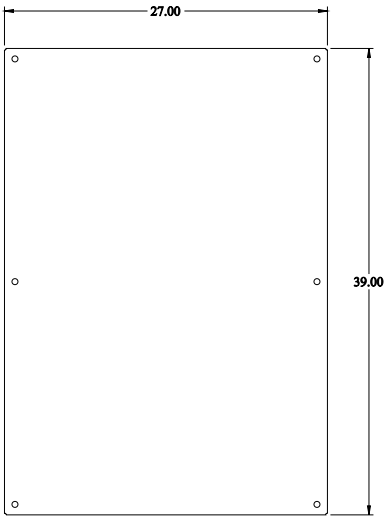

**INNER PANEL**

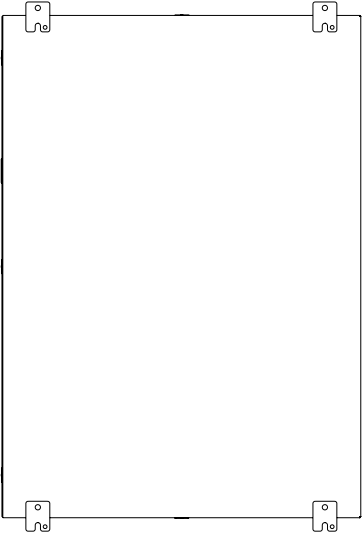

**BACK VIEW**

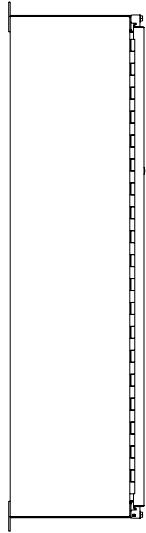

**SIDE VIEW**

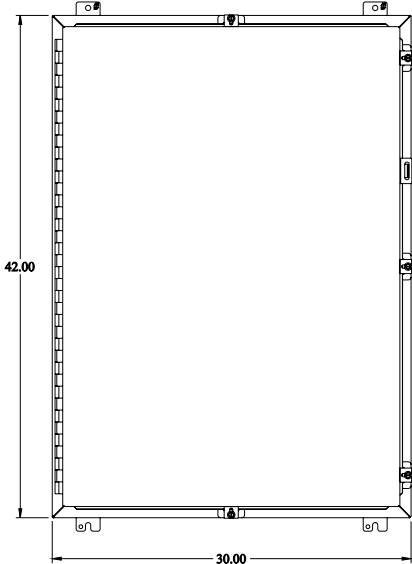

**FRONT VIEW**

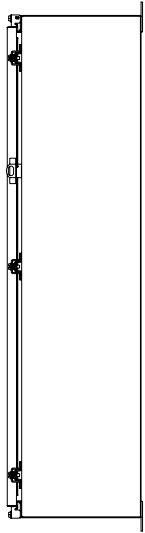

**SIDE VIEW**

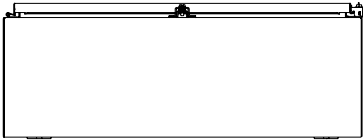

**BOTTOM VIEW**