

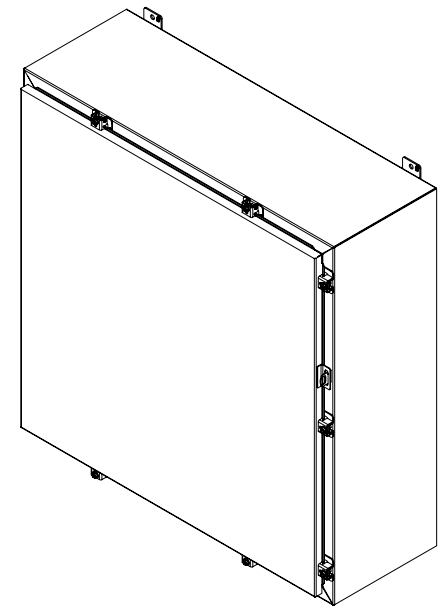

PART No. 1418N4S16LL12

Data subject to change without notice

Isometric drawing Not to Scale



ISOMETRIC VIEW

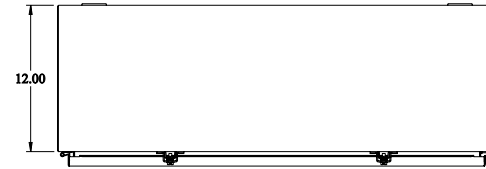

TOP VIEW

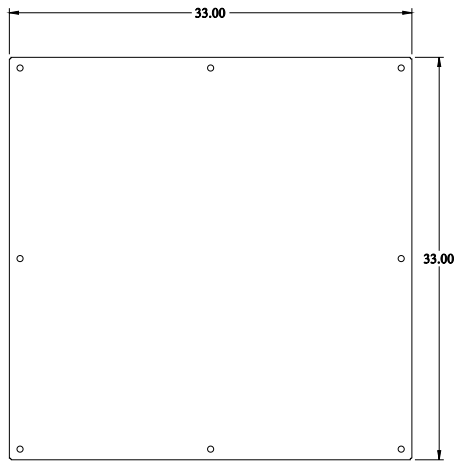

INNER PANEL

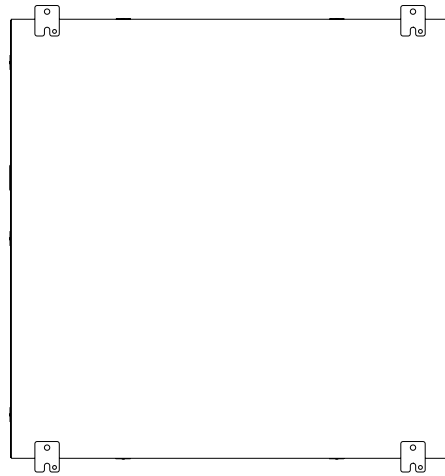

BACK VIEW

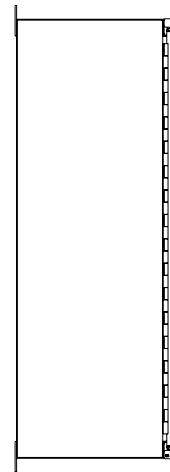

SIDE VIEW

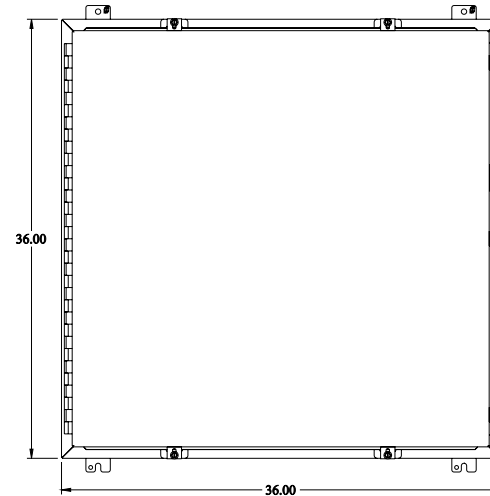

FRONT VIEW

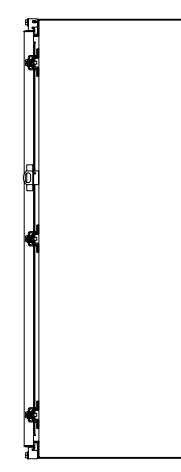

SIDE VIEW



BOTTOM VIEW