

PART No. CST6404

Data subject to change without notice
Isometric drawing Not to Scale

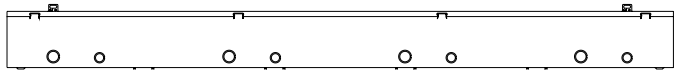

BACK VIEW

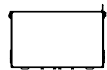

LEFT SIDE VIEW

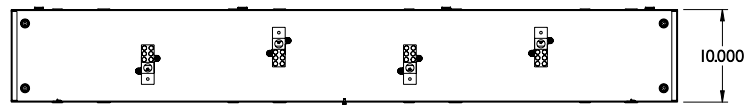

TOP VIEW - COVER REMOVED

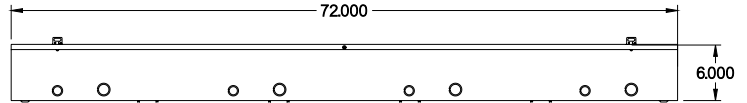

FRONT VIEW

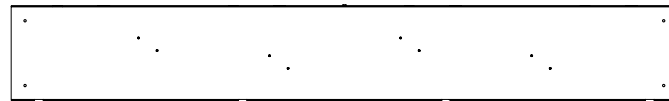

BOTTOM VIEW

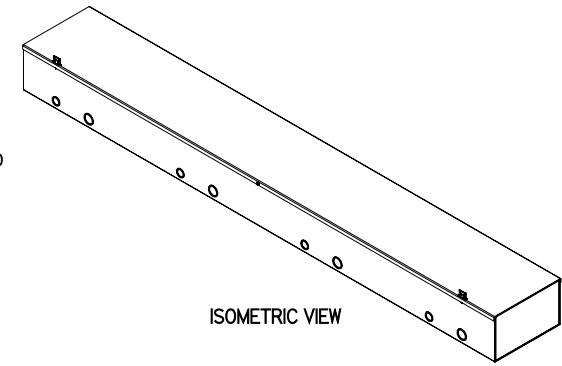

ISOMETRIC VIEW



RIGHT SIDE VIEW