 **PART No. CST6104**
Data subject to change without notice
Isometric drawing Not to Scale

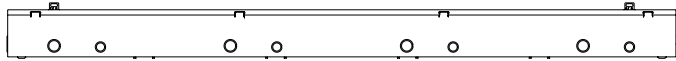

BACK VIEW

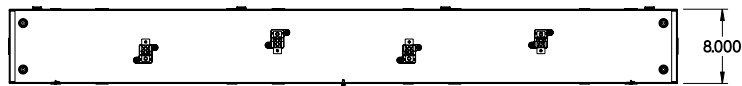

LEFT SIDE VIEW



TOP VIEW - COVER REMOVED

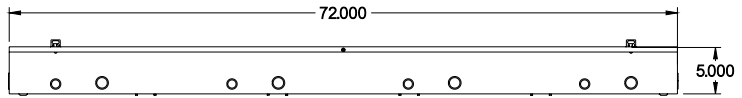

FRONT VIEW

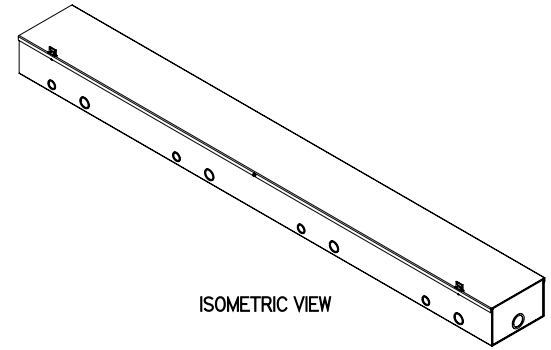

ISOMETRIC VIEW



RIGHT SIDE VIEW



BOTTOM VIEW