

PART No. CST373

Data subject to change without notice

Isometric drawing Not to Scale

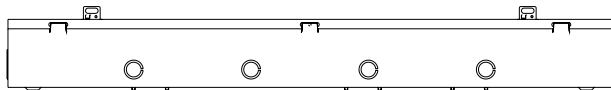

BACK VIEW

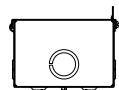

LEFT SIDE VIEW

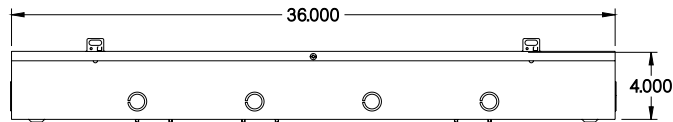

FRONT VIEW

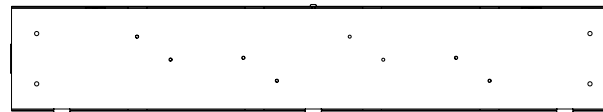

BOTTOM VIEW

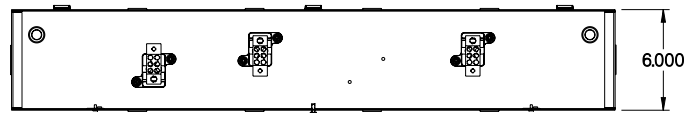

TOP VIEW - COVER REMOVED

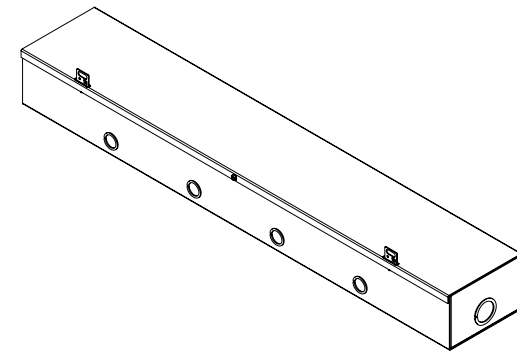

ISOMETRIC VIEW

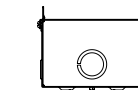

RIGHT SIDE VIEW