

PART No. CST3204

Data subject to change without notice

Isometric drawing Not to Scale

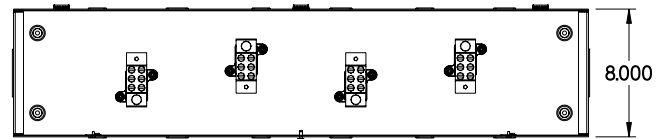

TOP VIEW - COVER REMOVED

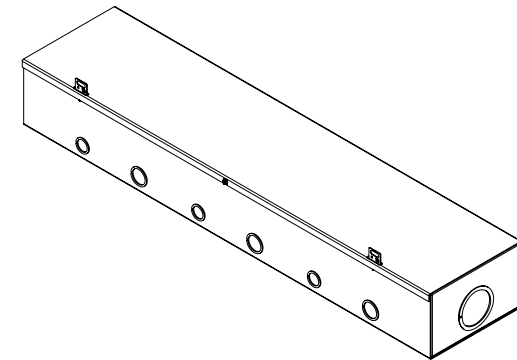

ISOMETRIC VIEW

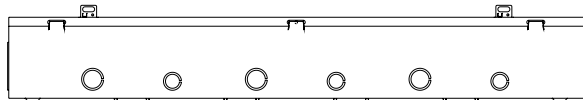

BACK VIEW

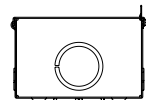

LEFT SIDE VIEW

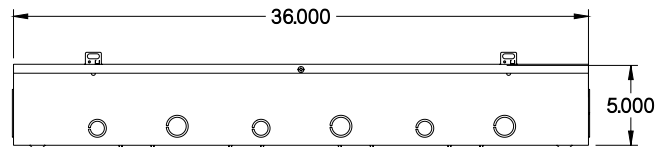

FRONT VIEW

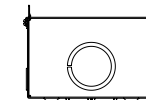

RIGHT SIDE VIEW

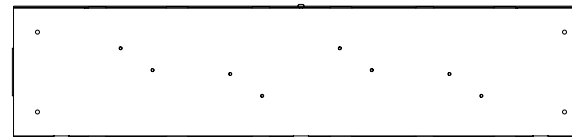

BOTTOM VIEW