

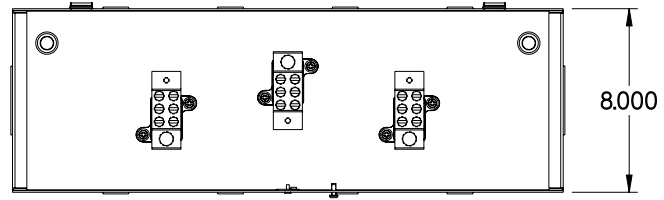

PART No. CST2203

Data subject to change without notice

Isometric drawing Not to Scale



TOP VIEW - COVER REMOVED

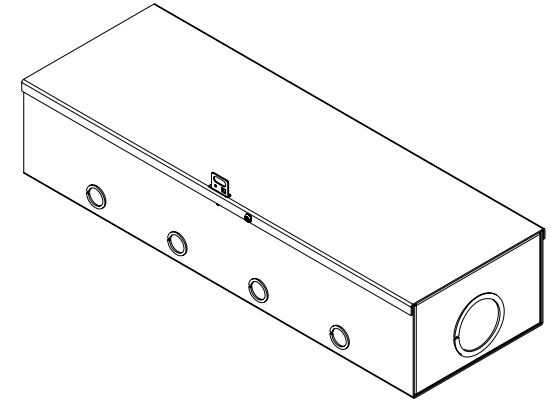

ISOMETRIC VIEW

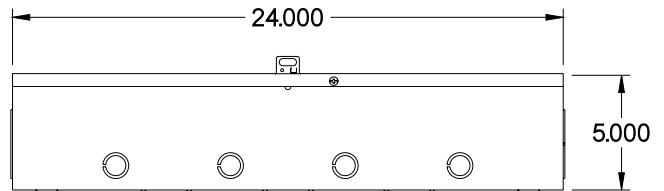

FRONT VIEW

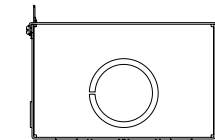

RIGHT SIDE VIEW

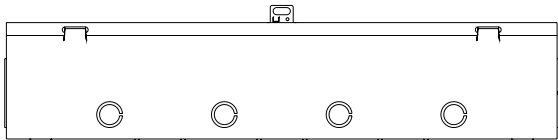

BACK VIEW

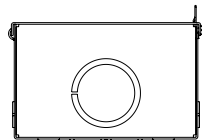

LEFT SIDE VIEW

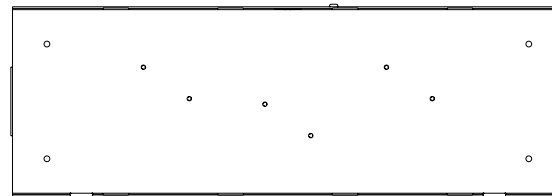

BOTTOM VIEW