

**PART No. C3R24248HCLO**

Data subject to change without notice  
Isometric drawing Not to Scale

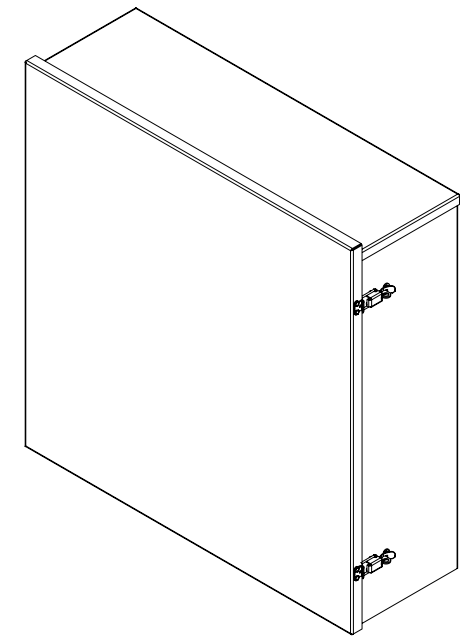

**TOP VIEW**



**ISOMETRIC VIEW**

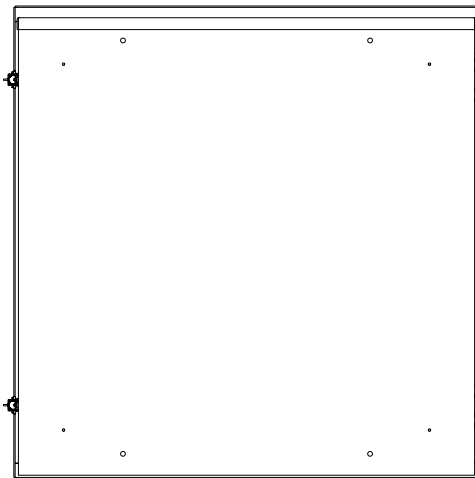

**BACK VIEW**

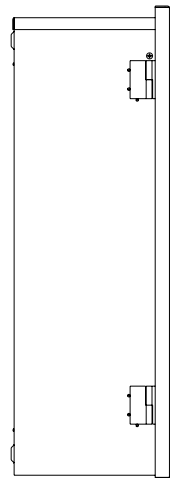

**LEFT SIDE VIEW**

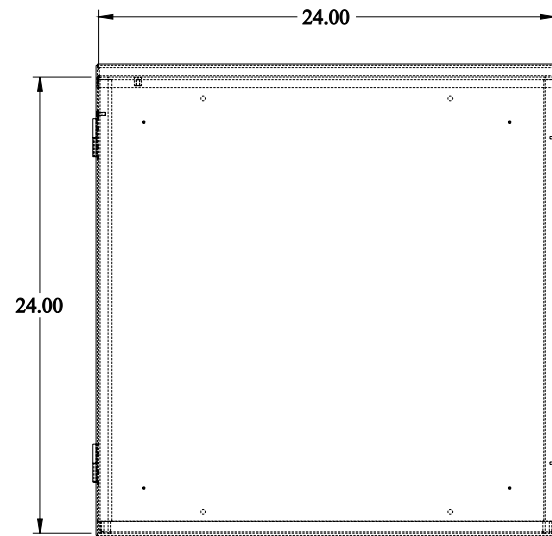

**FRONT VIEW**

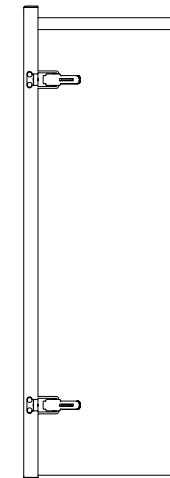

**RIGHT SIDE VIEW**



**BOTTOM VIEW**