

PART No. C3R242410SC

Data subject to change without notice
Isometric drawing Not to Scale

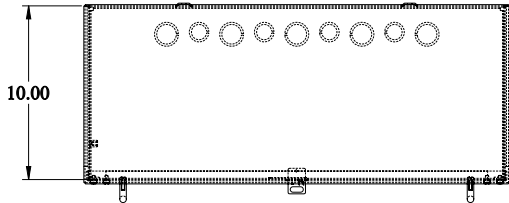

TOP VIEW

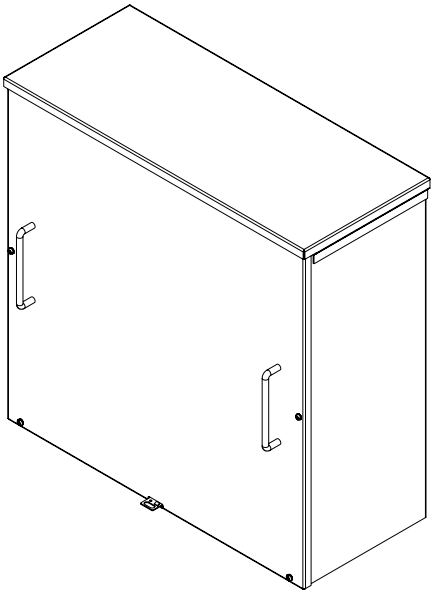

ISOMETRIC VIEW

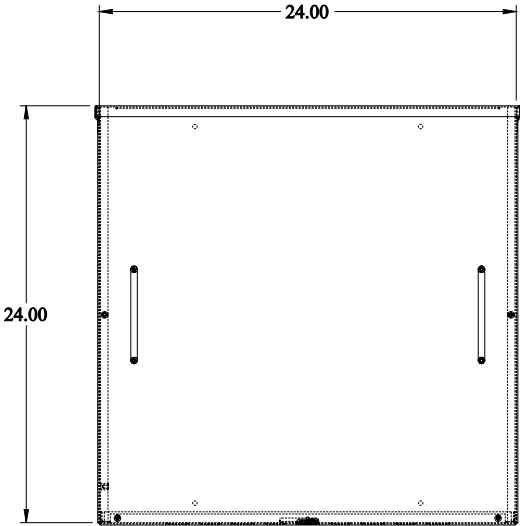

FRONT VIEW

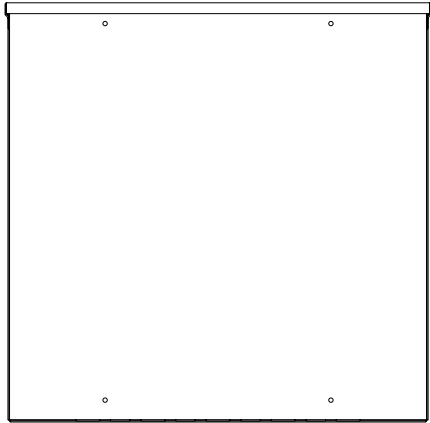

BACK VIEW

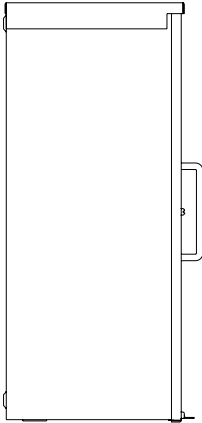

LEFT SIDE VIEW

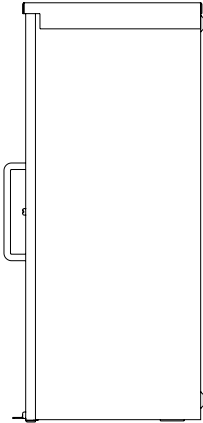

RIGHT SIDE VIEW

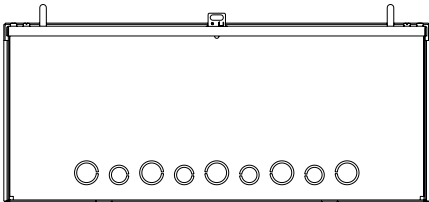

BOTTOM VIEW